

Ultrasound scanner

BLUE Vet



USER MANUAL

Produced by:

DRAMIŃSKI S.A.

Wiktora Steffena 21, Sząbruk
11-036 Gietrzwałd
Poland

Phone: +48 89 675 26 00
E-mail: sales@draminski.com
www.draminski.com

The Draminski Company has established and maintains a complete quality control system according to the requirements of **EN ISO 13485**. This system and the technical documentation are periodically revised by notifying unit No. **TUV Rheinland LGA Products GmbH**, Tillystrasse 2, 90431 Nuremberg, Germany, which takes part in compliance assessment.

The declaration of conformity can be obtained from our Sales Department:

Phone: +48 89 675 26 00
E-mail: sales@draminski.com

We wish the users of this product lot of success in taking care of your patients and we are sure that using our product you will provide good service to your patients.

All possible comments and notes of your customers concerning the device and this user manual will be accepted by DRAMIŃSKI Company with necessary attention.

Please feel free to call us at: **+48 89 675 26 00**
or e-mail us at: info@draminski.com

Developed by DRAMIŃSKI S.A.

All rights reserved.

Copying without the consent of DRAMIŃSKI S.A. is prohibited.

Content

1. Introduction.....	7
1.1. Information about user manual	7
1.2. Warnings and comments used in this user manual.....	7
1.3. Brief information on ultrasound examination	8
1.4. Basic information about the ultrasound scanner	8
2. User's safety.....	9
3. The list of DRAMIŃSKI BLUE Vet ultrasound scanner elements and accessories	10
4. Technical specification:.....	11
5. Construction of DRAMIŃSKI BLUE Vet ultrasound scanner	13
5.1. Body of the scanner.....	13
5.1.1. Multimedia connectors	13
5.1.2. Elements of the casing	14
5.2. Ultrasound probe.....	16
5.3. AC Adapter	16
5.4. Stand	17
6. Description of the user panel and available functions	18
6.1. Basic user panel (B, B+B, B+M modes)	18
6.2. Additional settings panel	19
6.3. Active fields	20
6.4. Panel in Color Doppler and Power Doppler mode	21
6.5. Panel in Pulse Wave Doppler	22
7. Preliminary starting procedure.....	23
7.1. General principles of using the touch panel	23
7.2. Support installation.....	23
7.3. Connecting the probe	24
7.3.1. Switching probes.....	24
7.4. Battery charge status check	25
7.5. Starting the device using the mains supply	25
7.6. Starting the device using the battery power supply.....	25
7.7. Finishing work	26
7.8. Transportation of the device	26
8. Preparation to perform ultrasound examination	27
8.1. Patient data.....	28
8.1.1. Data input	28
8.1.2. Selection of a patient from the database	28
8.1.3. Ending examination	28
9. Imaging modes	29
9.1. Choosing the imaging mode.....	29
9.1.1. B, B+B and 4B modes	29
9.1.1.1. Switching windows between B+B and 4B modes.....	29
9.1.2. M and B+M modes	29
9.1.3. Doppler modes: Color Doppler, Power Doppler and Pulse Wave Doppler	30
9.1.3.1. Switching between Color Doppler, Power Doppler and Pulse Wave Doppler modes.....	30
9.1.4. Vi-Probe	30
10. Description of the ultrasound scanner functions	31
10.1. Optimizing the image parameters.....	31

10.1.1. Gain control	31
10.1.2. Time Gain Control (TGC)	31
10.1.3. Frequency	31
10.1.4. Depth	31
10.1.5. Focus	32
10.1.6. Zoom	32
10.1.7. Dynamic range	32
10.1.8. Gamma	32
10.1.9. Advanced settings	33
10.1.9.1. Width of imaging sector	33
10.1.9.2. Interleaving	33
10.1.9.3. CI – compound imagingi	33
10.1.9.4. Frame averaging	33
10.1.9. D–Curve	33
10.1.9.6. LuciD	34
10.2. Freeze	35
10.3. Cine loop – continuous and frame–by–frame replay	35
10.4. Measurements	35
10.4.1. Length	36
10.4.2. Grid	36
10.4.3. Stenosis	37
10.4.4. Volume	37
10.4.5. Area	37
10.4.6. The area of ellipse	37
10.4.7. Follicle	37
10.4.8. OB/Gyn	37
10.4.8.1. ICC (Inner Chorionic Cavity)	37
10.4.8.2. BPD (Biparietal diameter)	38
10.4.8.3. Equine BPD Measurement	38
10.4.8.4. Equine ED	39
10.4.8.5. Equine VD	39
10.4.9. Cardiology	39
10.4.9.1. HR (Heart rate)	39
10.4.9.2. LA/Ao (Left Atrium to Aorta diameter ratio)	39
10.4.9.3. LV (Left Ventricle function)	39
10.4.9.4. Left Ventricle Volume – Simpson’s LVAM–LVAP method	40
10.4.9.5. Left Ventricle Volume – Simpson’s single plane method	40
10.4.9.6. Left Ventricle Volume – Bullet’s method	40
10.4.10. Edition of the measurements	40
10.4.11. Deleting all the measurements	41
10.5. Annotations and description of the series of images	41
10.5.1. ABC Annotations	41
10.5.1.1 Exporting and editing the ABC annotation list	42
10.5.1.2 Importing the ABC annotation list	42
10.5.2. Description of the series of imagesw	43
10.6. Optimization of B+M and M modes	43
10.6.1. Graph drawing speed selection in M mode	43
10.6.2. Setting the sampling line in B+M / M modes	43
10.6.3. Switching between M and B+M modes	43
10.7. Imaging with the function of color Doppler	43
10.7.1. Starting Color Doppler imaging	44
10.7.2. Switching between the Doppler modes: Color, Power, Pulse Wave; Doppler mode OFF	44
10.7.3. Doppler frame settings	44
10.7.3.1. Repositioning of the color box	44
10.7.3.2. Resizing of the color box	44
10.7.3.3. Steering angle of the color box	45

10.7.4. Setting parameters for the Doppler mode	45
10.7.4.1. [PRF] – Pulse Repetition Frequency	45
10.7.4.2. Doppler Frequency	45
10.7.4.3. Color gain adjustment	45
10.7.4.4. Frames averaging	45
10.7.4.5. [Wall filter]	45
10.7.4.6. [FPS quality]	45
10.7.4.7. Color invert	46
10.7.4.8. Color Threshold	46
10.7.4.9. [Color Range]	46
10.8. Power Doppler	46
10.8.1. Power Doppler settings	46
10.8.1.1. Postprocessing	46
10.8.1.2. Filtered / Not filtered averaging	46
10.9. Pulse Wave Doppler	46
10.9.1. Pulse Wave Doppler settings	46
10.9.1.1. Gain	47
10.9.1.2. Sampling gate depth	47
10.9.1.3. Insonation Angle	47
10.9.2. Registration of blood flow spectrum	47
10.9.3. Modification of baseline position	47
10.10. Measurement in the Color Doppler and Pulse Wave Doppler mode	47
10.10.1. Measurement of blood supply area [Flow Area] (Color Doppler)	47
10.10.1.1. [HR] – Heart Rate (Pulse Wave Doppler)	47
10.10.1.2. [AT] – acceleration time	48
10.10.1.3. [RI PI PSV EDV]	48
10.10.1.4. [Doppler Point]	48
10.11. Saving and loading the images and cine loops	48
10.11.1. Saving the image	48
10.11.2. Saving the Cine loop	48
10.11.3. Restoring patient examination	48
10.11.4. Editing the patient's data	49
10.12. Exporting data to external storage media	49
10.13. Exporting data in DICOM format	50
10.14. Image printing	50
10.14.1. Printing during examination	50
10.14.2. Printing of stored images	50
10.14.3. Printing multiple images on one sheet	50
10.15. Fullscreen	51
10.16. Presets	51
10.16.1. Presets activation	51
10.16.2. Presets saving	51
11. Advanced settings	52
11.1. Default	52
11.2. Clinic	52
11.3. Info	52
11.3.1. Software update	52
11.3.1.1. On-line update	53
11.3.1.2. Update using a USB flash drive	53
11.3.2. Selecting a printer	53
11.3.3. Remote access	53
11.3.3.1. Selection of remote access software	53
11.3.3.2. Setting up a remote access	53
11.3.3.3. Disabling remote access	54
11.3.4. Operating system protection	54

11.4. Date and time settings	54
11.5. Display	54
11.5.1. Display brightness	54
11.5.2. Touch screen calibration	54
11.5.3. Color temperature	54
11.6. Audio	55
11.6.1. Silent mode	55
11.7. Measurements settings	55
11.8. DICOM settings	55
11.8.1. Configuring the DICOM servers	55
11.8.2. Editing DICOM server settings	55
11.8.3. Data export in DICOM format onto an external USB device	56
11.9. WiFi	56
11.9.1. Installation of WiFi antenna drivers	56
11.9.2. Internet connection via WiFi antenna	56
11.10. Loop	56
11.10.1. Maximum video loop length	56
11.10.2. Choice of a style for creating file names exported to external storage	57
11.10.3. Selecting the extension of exported video loops	57
12. Charging and exploitation of the batteries	58
12.1. Checking the battery charge status before turning on the scanner	58
12.2. Checking the battery charge status during operation	58
12.3. Charging DRAMIŃSKI battery pack	58
13. Maintenance of the device	59
14. Troubleshooting	60
15. Symbols and marks used on the labels	61
16. Warranty	62

1. Introduction

1.1. Information about user manual



Individual chapters of the manual describe construction and accessories, as well as preparation for work, functions and operation of the DRAMIŃSKI BLUE Vet ultrasound scanner.

In no way this manual will substitute even a basic ultrasonography course. It is recommended that the user of the device attend an ultrasonography course organized by the authorized training unit.

1.2. Warnings and comments used in this user manual

Due to the need of emphasizing important content in this manual, the following ways of highlighting are used:



Warning! – When it is necessary to draw special attention due to safety of the patient or the user of the device.

Attention! – when it is necessary to draw attention due to protection of the device against damage or due to its proper operation.

Bold text – to draw attention to more important parts in the manual or to make them more distinct or visible.

Descriptions of the schemes and figures – to make recognition of some details easier.

Symbols used in the user manual do not fully inform about the safety instructions and that is why it is important to read the instructions (Chapter 2) and follow them!

Symbols used in the manual:

[text] – means name of a button

<x.x.x> – link to Chapter x.x.x

1.3. Brief information on ultrasound examination

Ultrasound devices are widely used in Veterinary. Particularly useful and commonly used is the method of real-time imaging which enables two-dimension graphic presentation of a tissue cross-section in the 256 grey-scale, the so called B-Mode (Brightness Mode). Additionally, Color Doppler ultrasonography used to evaluate the vascular flows is becoming more and more significant.

Diagnostic effectiveness of ultrasonography is considered to be high, but effects of working with this method are significantly impacted by the quality of the device, individual experience, the user's individual knowledge, as well as observing the ultrasound scanning standards and familiarization with the user manual.

1.4. Basic information about the ultrasound scanner

DRAMIŃSKI BLUE Vet is a modern device which can be powered from a built-in battery pack or directly from the mains (110–230 V). The ultrasound scanner is built based on a small-size computer system. The special features of the device are: touch operation, small size and weight as well as a strong aluminium casing which houses technically advanced electronics which guarantees top quality imaging.

DRAMIŃSKI BLUE Vet is a unique diagnostic device. Its small size and a built-in battery power supply make this ultrasound scanner a modern and ergonomic tool. It can be used as a desktop or portable device. It has a flat high quality LCD LED monitor which guarantees bright and high resolution image, which makes the work easier in almost any conditions.

DRAMIŃSKI BLUE Vet is an ultrasound scanner designed for diagnostic purposes, to monitor the progression of the disease and to evaluate the condition of the organs. Its main applications are:

- abdominal cavity,
- gynaecology and obstetrics,
- vascular flow,
- musculoskeletal system,
- heart,
- lungs imaging,
- and in anaesthesiology.

A user can use black and white real time imaging modes as well as Color, Power and Pulse Wave Doppler.

2. User's safety



Warning! – The user's and the patient's safety depends on observing the below mentioned instructions!

1. DRAMIŃSKI BLUE Vet should be used for diagnostic purposes and by the trained staff only – veterinarians proficient in ultrasound diagnostics.
2. It is necessary to disinfect the probe before each use. Other elements of the ultrasound scanner should be disinfected in reasonable situations in which they could have a contact with infectious substances.
3. It is forbidden to use the ultrasound scanner with high frequency (HF) devices at the same time.
4. The ultrasound scanner cannot be used for transesophageal echocardiography (TEE) examinations.
5. In the places where explosive and anaesthetic gases are used the use of the ultrasound scanner is prohibited for safety reasons.
6. The device is suitable for indoor use.
7. It is recommended the user of the ultrasound scanner perform regular technical inspections every two years at the manufacturer's facility or at the approved service point. It will guarantee the highest level of safety of the patients.
8. It is forbidden to carry out ultrasound diagnostics when carrying out defibrillation.
9. It is forbidden to disassembly the device, repair and modify in any way it by the user except for the procedures stated in this manual.
10. It is recommended the users of this ultrasound scanner check before the examination the condition of the probe, cable and the connector. Do not use the probe if any of these elements is damaged.
11. If mechanical damages of the probe, cable or connector are noticed it is necessary to send the device to the service point authorised by DRAMIŃSKI.
12. Even though the ultrasound scanner has a strong construction in order to avoid mechanical damages it is recommended to follow the instructions presented in this manual.
13. Exposing this device to strong solar radiation should be avoided. Regarding working, storage and transport conditions, it is advised to follow the instructions on the labels of the device and its parts.
14. It is forbidden to modify the device by the user.
15. DRAMIŃSKI BLUE Vet is an electric device which can be a source of electromagnetic radiation. Other electric devices can interfere with its work, which is why it is recommended to limit the number of other electric devices working nearby.
16. When its service life expires in order to avoid risk to the environment, the device and the accessories should be disposed of by specially trained units according to the applicable regulations or sent back to the manufacturer.
17. During the ultrasound examination the device cannot be connected to the ETHERNET (via LAN connector).
18. It is recommended to connect medical grade external monitors and printers.
19. In order to avoid electric shock the device should be connected to a grounded outlet.

3. The list of DRAMIŃSKI BLUE Vet ultrasound scanner elements and accessories

#	Name and description	Quantity
1	DRAMIŃSKI BLUE Vet Body with built-in battery	1
2	Ultrasound probe	1
3	AC adapter	1
4	Display port to HDMI adapter	1*
5	Stand	1
6	User manual and warranty card	1
7	Transport case	1
8	Stand on wheels	optional
9	Low table on wheels	optional
10	Hooks for carrying belts	optional
11	Carrying belts	optional
12	WiFi antenna - USB	optional
13	Power bank	optional
14	SSD disc 120 GB	optional
15	Sunshield	optional

* Depends on the version of the ultrasound scanner

4. Technical specification:

Application	Ultrasound diagnostics of animals
Imaging Modes	B Mode; B+B Mode; 4B Mode; M Mode; B+M Mode; Colour Doppler; Power Doppler; Pulse Wave Doppler
Frequency of the system	1–14 MHz (depends on the probe)
Dynamic focus	Yes
Beam control	Vi-probe (virtual phased array on convex probes and virtual convex on linear probes) CI (compound imaging): x 3, x 5, x 7.
Interleaving	Yes (medium, normal, strong, very strong)
Image managing	Freeze Zoom 60 – 300% of the initial image, 20%/step Full screen Saving of images and cine loops (512 frames) Data export to the DICOM server
Presets	Cat Abdomen, Cat Cardio, Cat Kidney, Cat Liver, Cat Spleen, Cat Bladder, Dog Abdomen L, Dog Abdomen M, Dog Abdomen S, Dog Cardio L, Dog Cardio M, Dog Cardio S, Dog Kidney, Dog Liver, Dog Spleen, Dog Urinary Bladder, Horse Abdomen, Horse Dorsal, Horse DDFT, Horse Eye, Horse Pastern, Horse Pelvis, Horse Reproductive, Horse SDFT, Horse Shoulder, Horse Deep tendon, Horse Superficial tendon
Greyscale	256 shades of grey, D-Curve (grayscale optimised for human's eye perception)
Image postprocessing	LuciD (contrast enhancement, sharpening, better tissue differentiation)
Color temperature	Warm, cold, neutral
User interface	Menu in languages: Polish, English, Arabic, Croatian, French, Spanish, Korean, German and Russian. Imaging parameters adjustments
Measurements	Basic: Area, Distance, Ellipse, Grid, Stenosis, Volume, Obstetric package: aging tables for different species, Doppler: Doppler Point, PSV, EDV, AVG, RI, PI, AT
System	Integrated with PC
Screen	LCD LED, 12"
Functions control	capacitive touch panel
Images and cine loops memory	30 GB, images and cine loops with description, patient data and examination date
Data transfer standard	DICOM 3.0

Data transmission to an external device	Via USB
Exported data file format	PNG for images, AVI, MP4, MOV for cine loops
Probe ports	One port, automatic probe detection
Multimedia connectors	WS version: 2 x USB 3.0, 1 x LAN, 1 x Display Port AV version: 1 x USB 3.0, 1 x USB 2.0, 2 x LAN, 1 x HDMI
Medical Device Class	Class I
Type of applying part	BF type
Power supply	1. AC adapter, Model XP Power AHM100PS19 Output: 19V 5,26A, 2. Li-ion built-in battery 14,4V 6,8Ah
Continuous work on battery power supply	Up to 2,5 hours
Battery charging time	4 hours
Low battery level indicator	Graphic; Acoustic signal to indicate the charge level when the device is turned off; Acoustic signal informing about low battery when the device is switched on
Start-up time	Approx. 25s. (cold start)
Housing	Metal: duraluminium
External dimensions	width 31.0 cm, height 28.0 cm, depth 6.5 cm
Weight	4 kg with the support
Working temperature	+ 10°C to + 40°C
Storage temperature	+ 5°C to + 40°C
Transport temperature	- 10°C to + 40°C
Working humidity	>90% without condensation
Storage humidity	>90% without condensation
Transport humidity	>90% without condensation
Working pressure	From 700 to 1060 hPa
Storage pressure	From 700 to 1060 hPa
Transport pressure	From 700 to 1060 hPa
International protection rating	IP30
Power consumption	2.5A
Optional accessories	Stand on wheels, Table on wheels, Gel stand-off, Hooks for carrying belts, Carrying belts, WiFi antenna - USB, Power bank, SSD disc 120 GB, Sunshield

5. Construction of DRAMIŃSKI BLUE Vet ultrasound scanner

The device consists of:

1. Body of the scanner
2. Ultrasound probes
3. AC adapter
4. Support

5.1. Body of the scanner

The housing is made of high-quality aluminum.

On the front of the body there is a high quality 12" LCD LED display with a touch screen. It has a wide viewing angle and high resolution which guarantees high quality of an ultrasound image. The touch panel is dedicated to control the system.

The user panel and its features are described and shown on figures in further parts of this manual.

On the back side of the body there are: port for probe connector, port locking lever, loudspeaker, ventilation inlets and outlet, system for mounting the support or attaching the scanner to the wheel stand.

On the right side of the body there are ON/OFF button and power supply socket.

On the left side of the body there is a set of a multimedia connectors (WS version: 2 x USB 3.0, 1 x LAN, 1 x Display Port; AV version: 1 x USB 3.0, 1 x USB 2.0, 2 x LAN, 1 x HDMI) – located under a sliding cover.

5.1.1. Multimedia connectors

The following connectors are located under the cover, to the right, depending on the version of the device:

- WS version: 2 x USB 3.0, 1 x LAN, 1 x Display Port,
- AV version: 1 x USB 3.0, 1 x USB 2.0, 2 x LAN, 1 x HDMI.

The version of the device is subject to regional availability. The functions of both versions are identical, and the differences between them are only in the multimedia connectors, which are used for:

- 2xUSB – exporting data to an external flash drive, updating the software,
- HDMI – connecting the external display,
- 2xLAN – connecting to a Dicom Network, updating the software.



Warning!

It is advised to connect only medical grade peripherals to the multimedia connectors!



Warning!

During the ultrasound examination the device cannot be connected to the ETHERNET (via LAN connector).



Warning!

It is forbidden to connect any peripherals to the HDMI and USB connectors during an ultrasound examination!

Attention!

The ultrasound scanner has a strong construction, however it should be operated and transported with due care in order not to expose the device to strong impacts to avoid potential damage. Protect the device from foreign objects getting inside the casing through the ventilation holes.

5.1.2. Elements of the casing

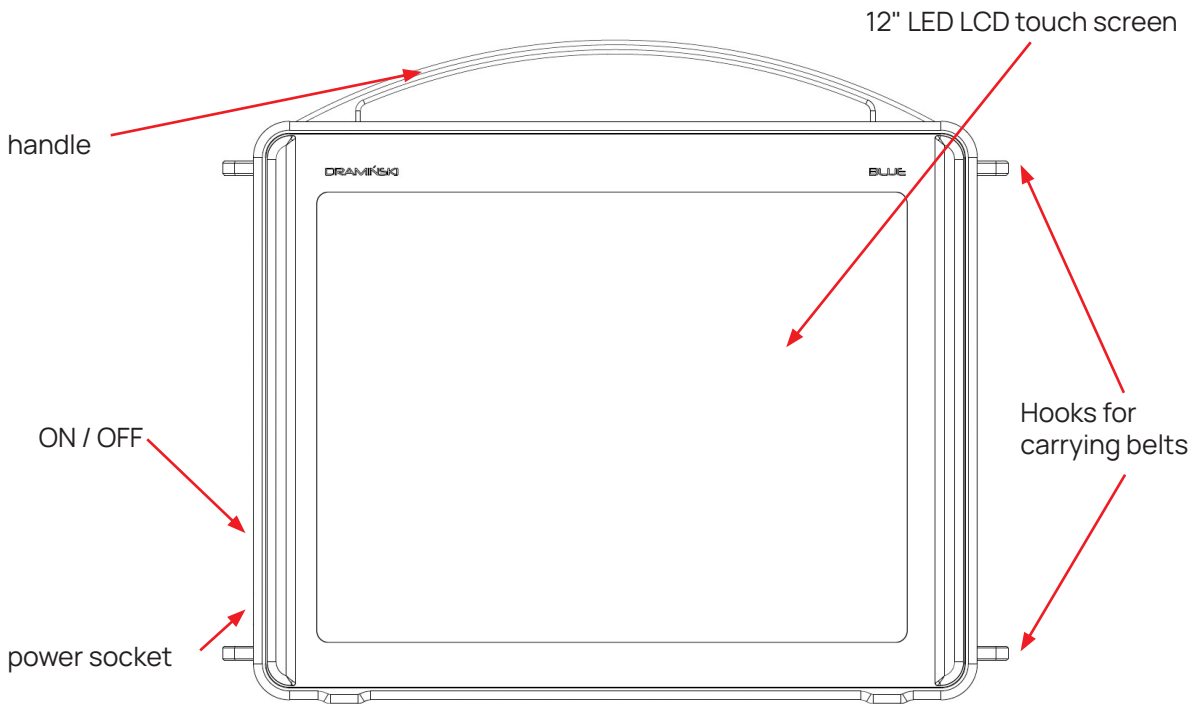

Fig. Elements of the casing. Front view.

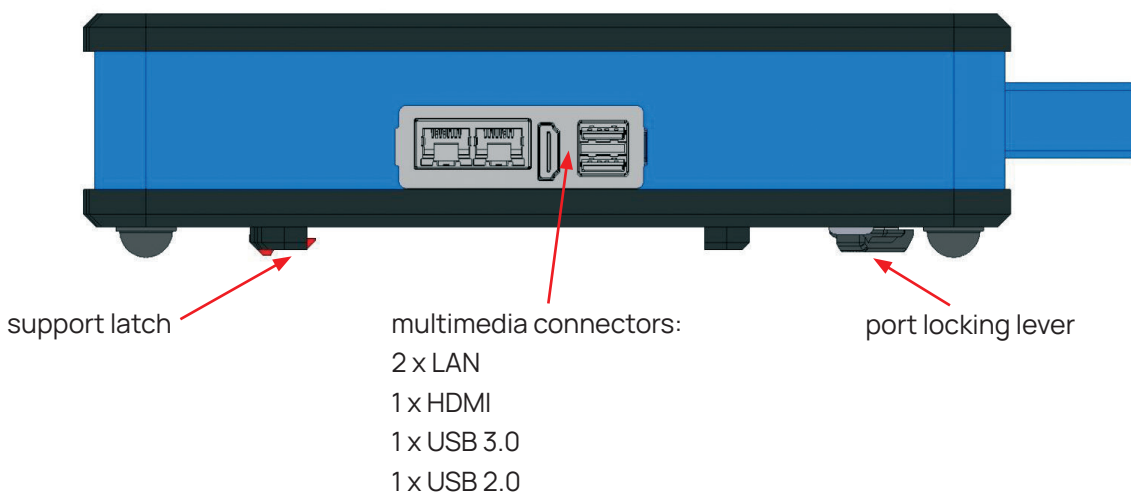

Fig. Elements of the casing. AV version. Right side view.

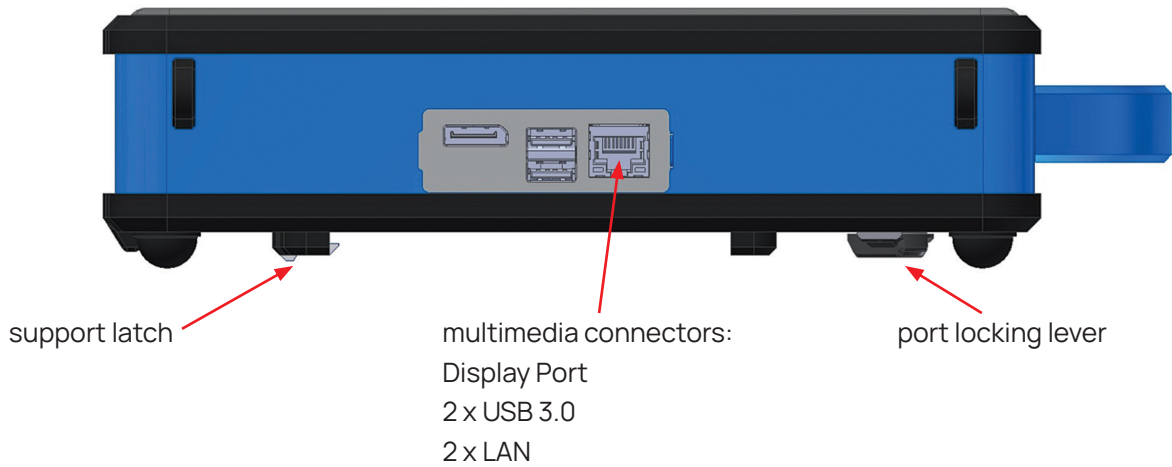

Fig. Elements of the casing. WS version. Right side view.

Attention!

It is recommended to connect medical grade external monitors and printers.



Warning!

For safety reasons external devices should not be connected to the ultrasound scanner when examination is in progress.

During the examination the ultrasound scanner must not be connected to the ETHERNET network via LAN.

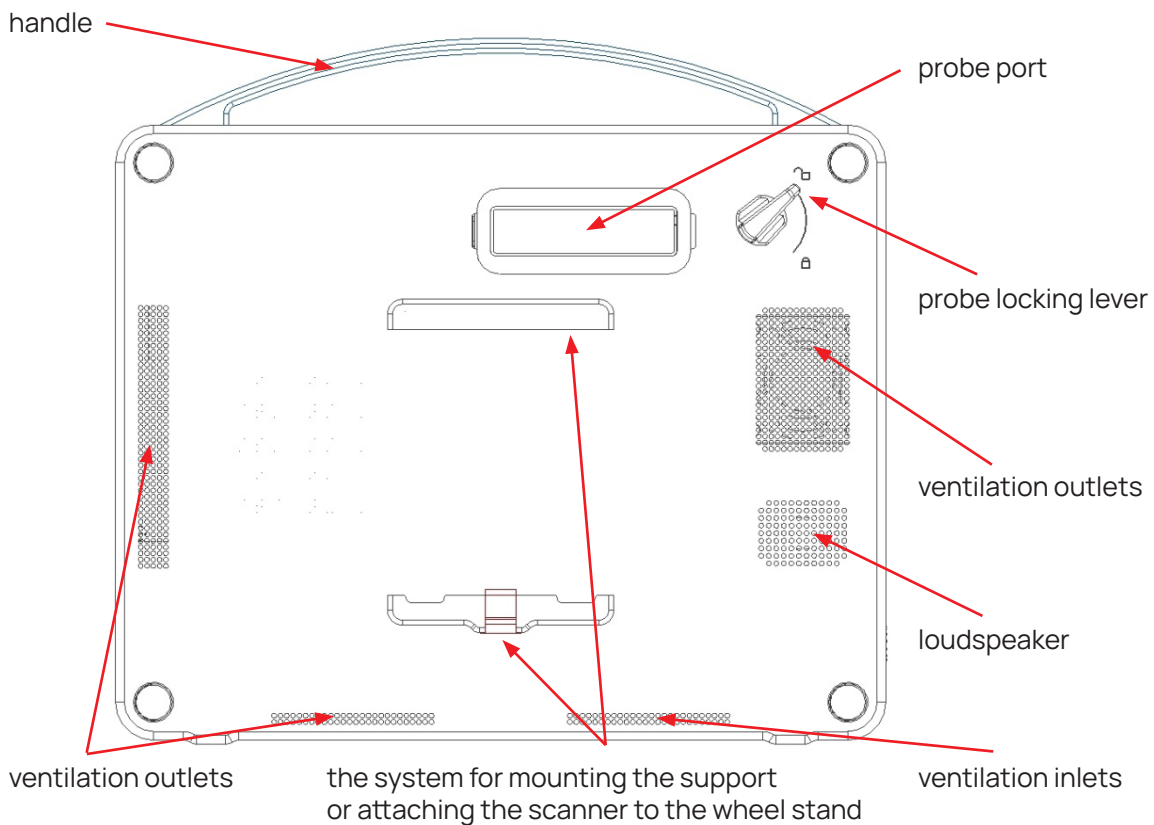

Fig. Elements of the casing. Rear view.

5.2. Ultrasound probe.

List of DRAMIŃSKI ultrasound probes compatible with BLUE:

CONVEX 3,5 MHz R50

CONVEX 3,5 MHz R60

LINEAR 10 MHz 40 mm

ENDOCAVITY 6,5 MHz 10 mm

MICROCONVEX 6,5 MHz 15 mm

P-PROBE 6,5 MHz R20

RECTAL LINEAR 7 MHz 60 mm

OPU 6,5 MHz R10

Protection levels for the probes:

- IPX1 for socket, cable and housing,
- IPX7 for head of the probe.

Attention!

It is possible to use other types of electronic probes. Users interested in other types of ultrasound probes should contact the manufacturer of the DRAMIŃSKI BLUE Vet ultrasound scanner at ultrasound@draminski.com.

5.3. AC Adapter



Class I Medical Device

Input: 100–240V ~ 1.2A, 50/60Hz

Output: 19V 5,26A

The adapter is used to power the DRAMIŃSKI BLUE Vet device only. The parameters of the adapter guarantee safe operation for the user, the patient and for the device itself.

Fig. AC adapter Model: XP power AHM100PS19

Attention!

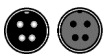

The shape of the power supply plug is closely matched to the shape of the socket. Do not force the plug if you feel resistance. Proper positioning of the plug in relation to the socket shall ensure easy connection.



Warning!

The device can be powered from the mains only by using attached certified adapter. The use of another adapter can cause damage to the user and can permanently damage the device.

All service repairs must be performed with the power off.



Warning!

If there is necessary to stop the work of the device the power button should be pressed and held for approximately 4 seconds.



Warning!

In order to avoid electric shock the device should be connected to the grounded mains.

5.4. Stand

The stand can be mounted on the rear side of the scanner. After setting up device is positioned at 60° angle to the floor.

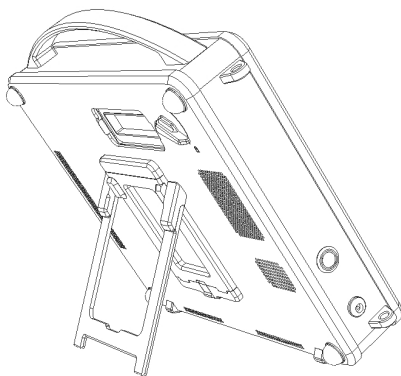

When moving the ultrasound scanner, it is recommended to fold the stand flat.

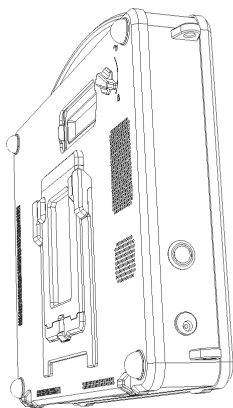

6. Description of the user panel and available functions

6.1. Basic user panel (B, B+B, B+M modes)

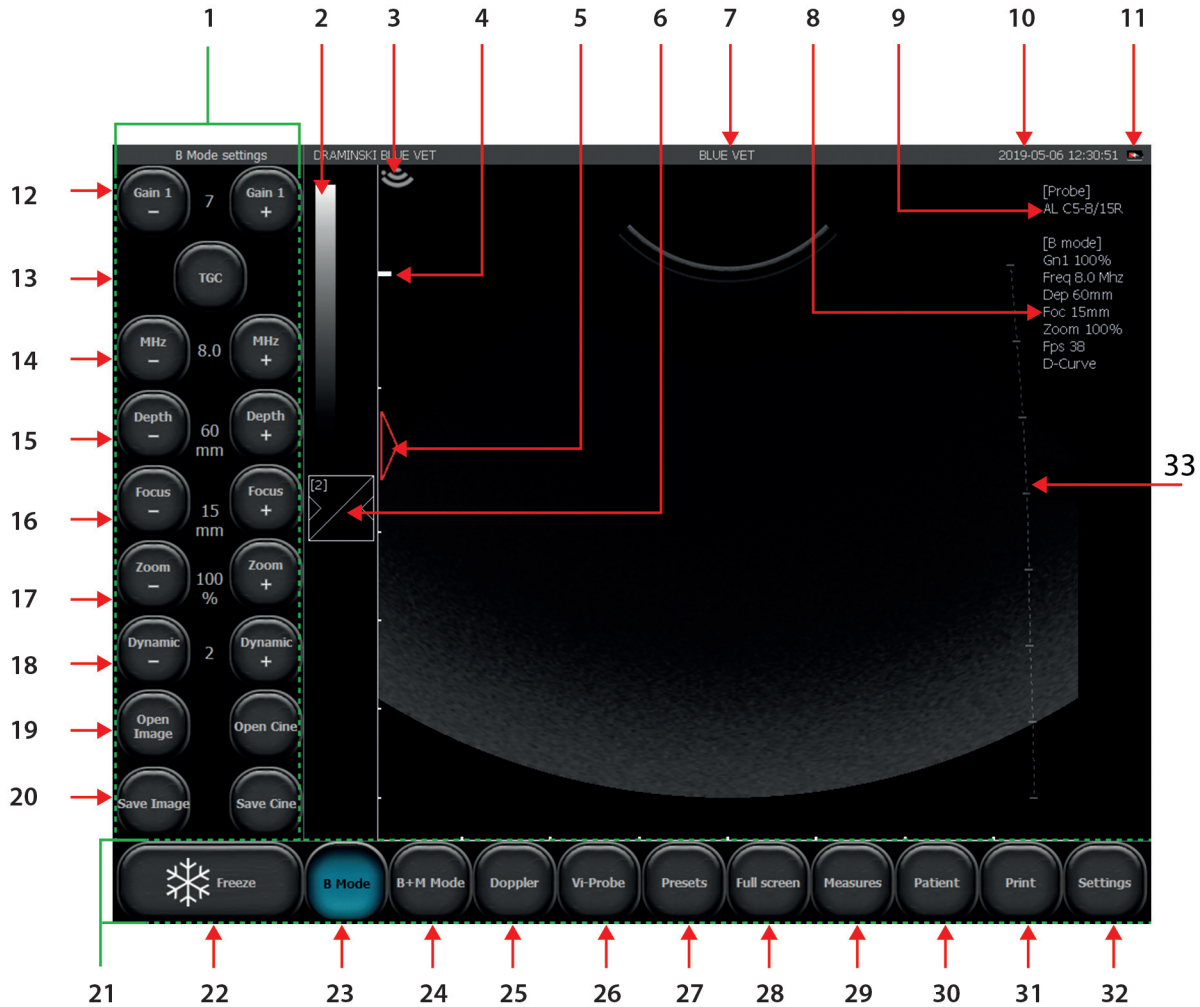

Fig. Basic user panel.

1. Tool panel
2. Greyscale, Negative/Positive
3. Probe indicator
4. Focus position
5. Scale
6. Gamma setting
7. Clinic name / Preset name
8. Current working parameters
9. Probe's symbol
10. Date and time
11. Battery indicator
12. Gain control
13. TGC control
14. Frequency control

15. Depth control
16. Focus control
17. Zoom control
18. Dynamic range
19. Load image / load cine
20. Save image / save cine
21. Mode panel
22. Freeze
23. Imaging mode: B, B+B, 4B; Vi-Probe, D-Curve
24. Imaging mode: M, B+M
25. Imaging mode: Doppler
26. Vi-Probe
27. Presets
28. Full Screen
29. Measures
30. New patient
31. Print
32. Advanced and system settings
33. TGC configuration

6.2. Additional settings panel

The additional settings panel appears after pressing the Settings key.

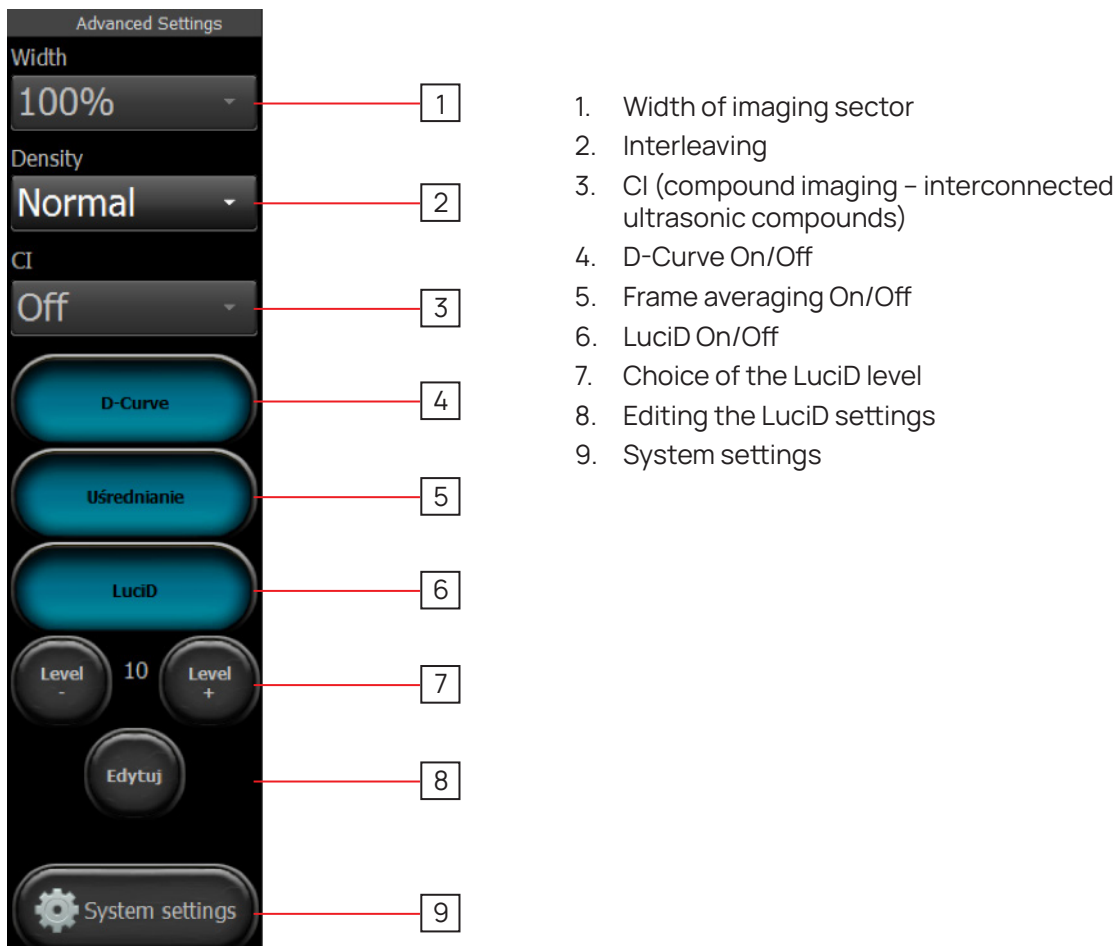

6.3. Active fields

Active fields are zones in the image which serve to change some parameters skipping the buttons on the user panel.

In the image sector there are four peripheral active zones which are used to change:

- gain setting,
- focusing level,
- depth of scanning.

The central active field enables moving the image in the zoom mode.

In B+B and 4B modes active fields are placed alike in each separate window.

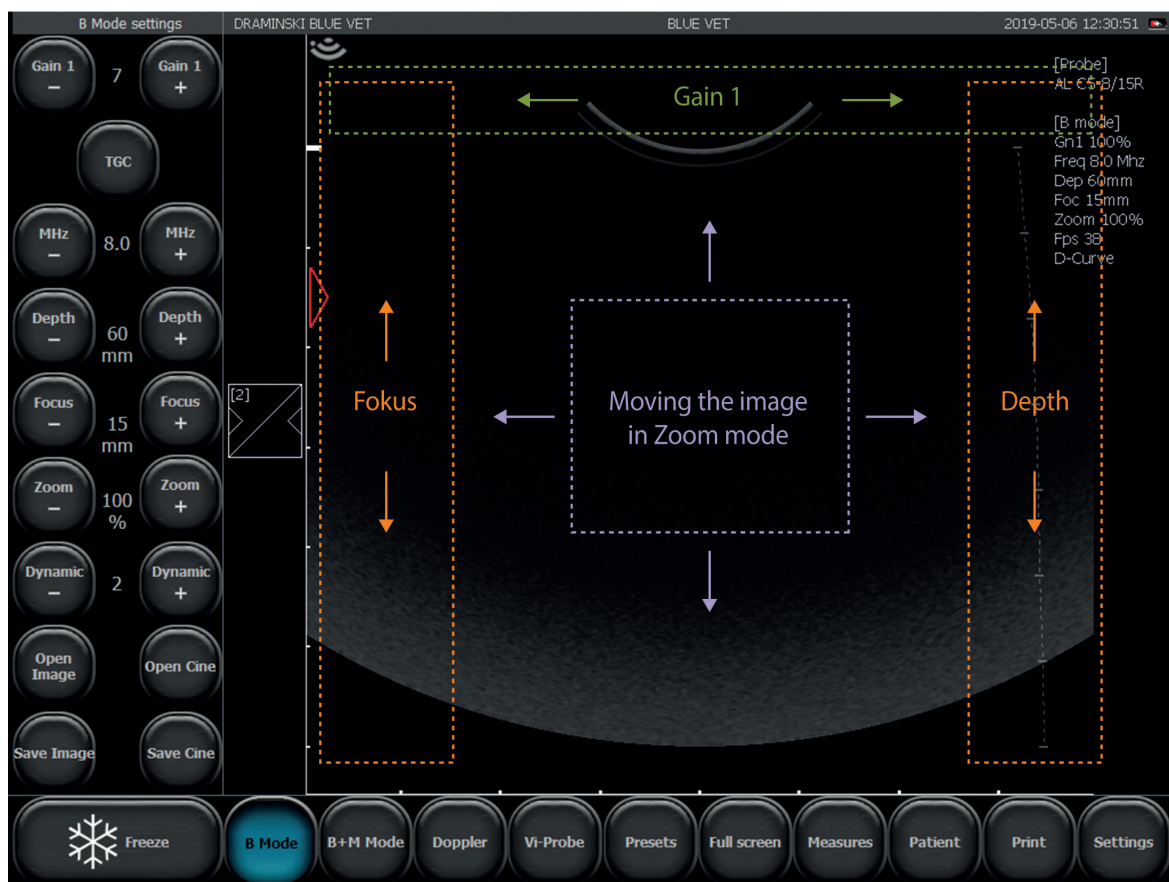

Fig. Active fields

6.4. Panel in Color Doppler and Power Doppler mode

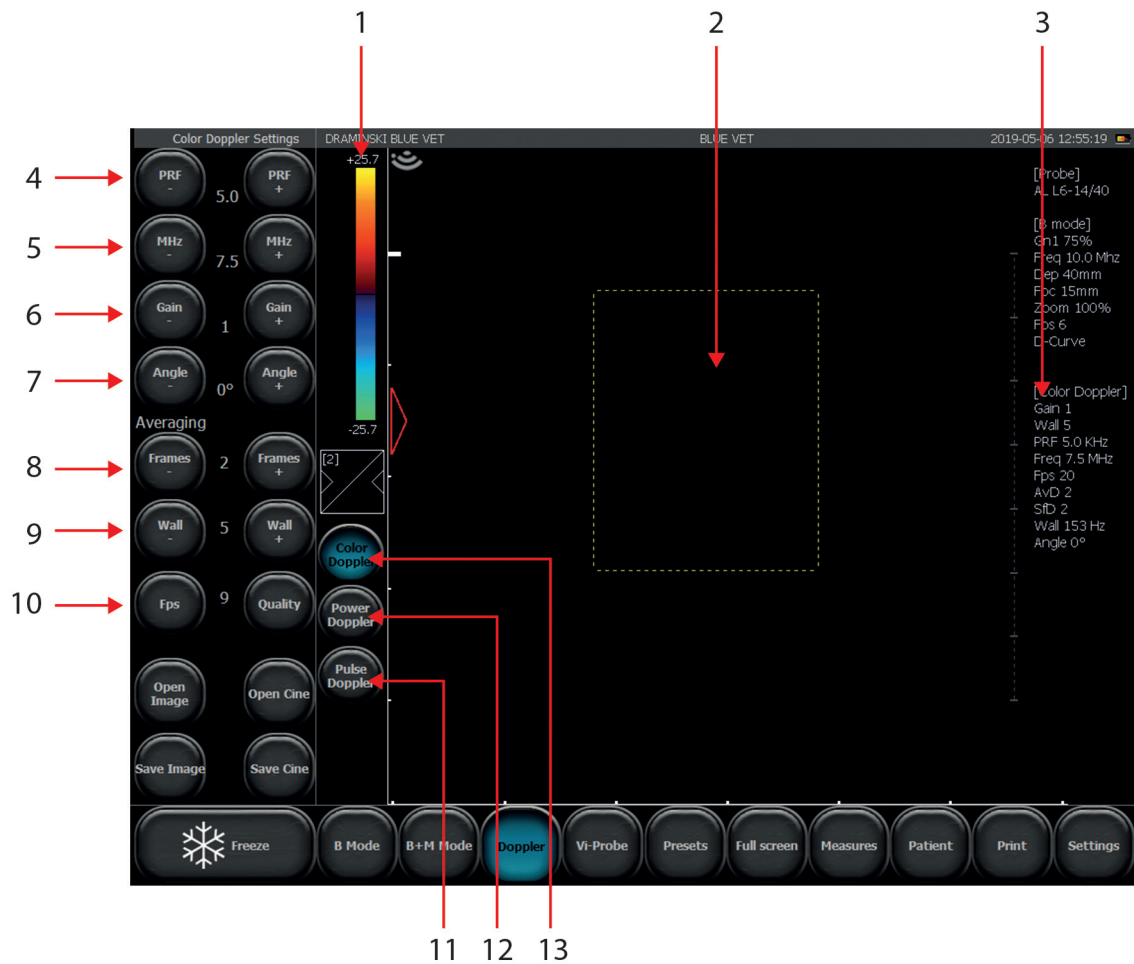

Fig. User Panel in Colour Doppler mode.

1. Color map / color invert, Color treshold, Color range.
2. Doppler frame
3. Current Color Doppler settings information
4. PRF – Pulse Repetition Frequency
5. Doppler frequency control
6. Doppler gain controll
7. Steer (for linear probes only)
8. Frame averaging
9. Wall filter
10. FPS: Quality
11. Pulse Wave Doppler
12. Power Doppler
13. Color Doppler

Other buttons and information displayed on the screen are the same as for mode B.

6.5. Panel in Pulse Wave Doppler

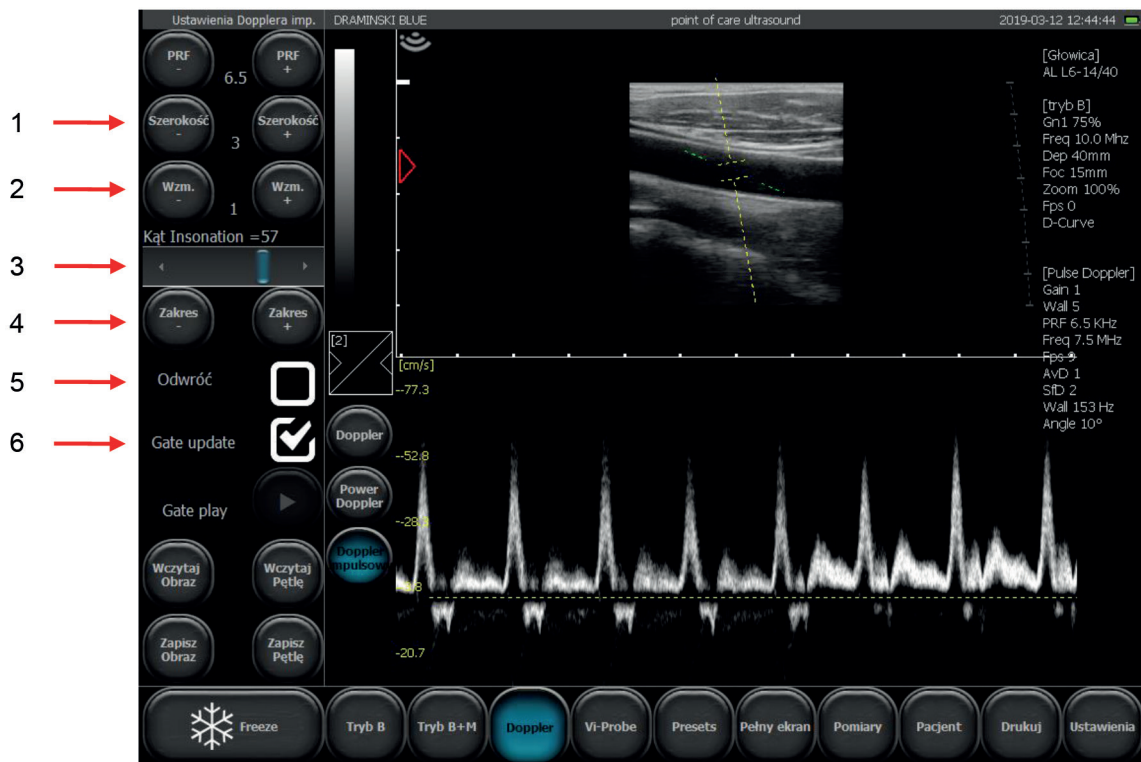

Fig. User Panel in Pulse Wave Doppler Mode

1. Pulse Repetition Frequency (PRF) settings
2. Gate width
3. Gain
4. Insonation angle
5. Gate depth control
6. Invert
7. Update. Switching between B and Pulse Wave Doppler window.



Warning!

Only qualified and specially trained personnel can operate the system and carry out ultrasound examinations.

7. Preliminary starting procedure.

Attention!

Function control of the ultrasound scanner is performed via the touch panel. Only turning ON and OFF is done by use of the button on the right side of the device.

7.1. General principles of using the touch panel

1. Capacitive touch panel can be operated by a hand in a glove.
2. The panel should be wet-cleaned and disinfected with the help of special sprays or foams.
3. Dry-cleaning of the panel is recommended with the help of soft dusters.
4. Thorough cleaning of the panel should be carried out when the device is switched off.

7.2. Support installation

To mount the support, attach one side to the upper bar of mounting system and push the other side towards the scanner. When you hear the click of the latch, the support has been mounted.

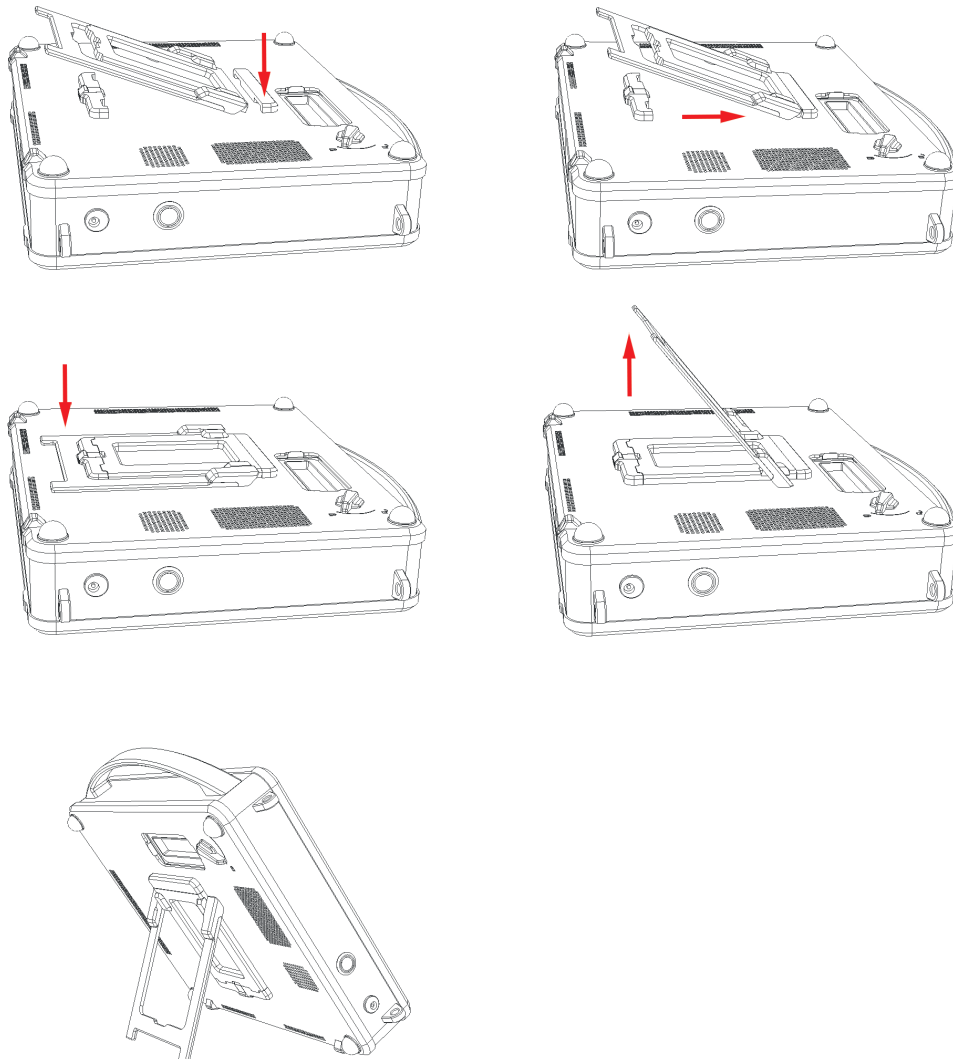

Support installation

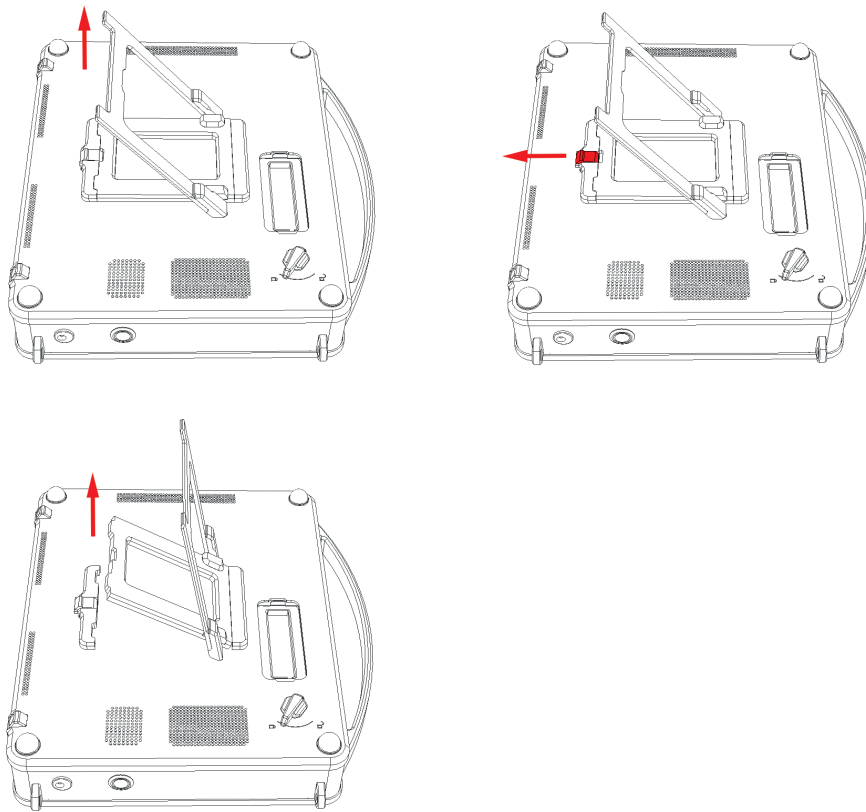

Support deinstallation

7.3. Connecting the probe

Attention!

The probe connector is a technologically advanced mechanism. It should be protected against mechanical damage, dirt and moisture. The probe cable should be protected from excessive loads, strong and repeated bending and shaking.



Before connecting the probe make sure that the probe locking lever is in  position.

After fitting the probe connector tightly in the socket, switch the probe locking lever to  position, to prevent the connector from disconnecting and provide proper contact between the connector and port.

7.3.1. Switching probes

BLUE ultrasound scanner has only one probe port.

You do not have to turn the scanner off, If you want to switch between the probes.

Turn the probe locking lever to  position and disconnect the connector from the port. The image will be frozen. Fit the connector of the second probe tightly in the port and switch the probe locking lever to  position. The image will be unfrozen and the probe will be recognized automatically.

When this operation is being performed the screen will show the following messages:

„Probe OFF” – probe is unlocked,

„Probe ON” – probe is locked.

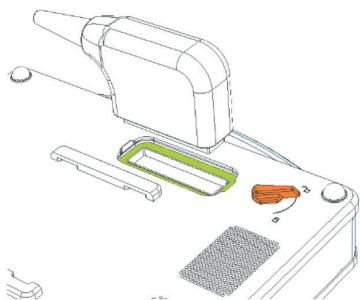



Fig. Probe port on the rear side of the scanner. The probe locking lever is in  position.

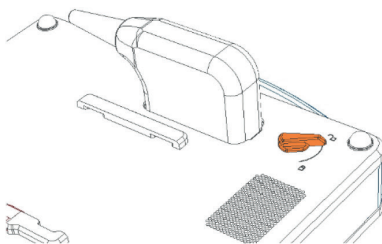



Fig. Connector is correctly fitted in the port. The probe locking lever is in  position.

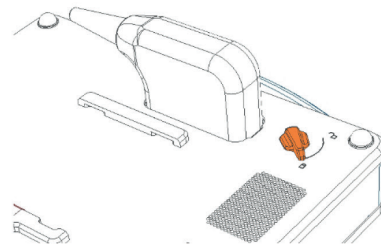



Fig. Connector is correctly fitted in the port. The probe locking lever is in  position.



Warning!

Regarding the complicated construction of probes it is necessary to use them with due caution and protect against falls or damage. The active surface (lens of the probe) should be protected against mechanical damage, for example, do not scrub it during cleaning.

The probe is the element of the ultrasound scanner which should be disinfected before each use.

7.4. Battery charge status check

To check the battery charge status when the device is turned off, press the power button briefly. If the battery is charged, the device will emit 1 to 4 acoustic signals*, with one signal corresponding to 25% battery charge. <7.4.1.>

* No signal means the battery is deeply discharged or this function has been disabled after activating the silent mode in the Audio tab of the Settings menu.

While the device is on, the battery's state of charge is displayed in the top right-hand corner.

7.5. Starting the device using the mains supply

1. Connect the adapter to the 110–230 V / 50–60 Hz grounded outlet.
2. Connect the adapter's connector to the socket on the device casing. Note that the plug of the power supply is closely matched in shape to the socket.
3. Turn the device on by pressing the power supply button on the left of the device for 1 second.
4. Wait for the system of the ultrasound scanner to upload and the user panel to appear on the screen.
5. Check if the connected probe is adequate with the symbol on the screen and if there is a response on the image when you touch the head of the probe.

7.6. Starting the device using the battery power supply

1. Make sure the battery is charged by briefly pressing the power button. <7.4.1.>
2. Turn the device on by pressing the power key on the left side of the device.
3. Wait for the system of the ultrasound scanner to upload and the user panel to appear on the screen.
4. Check if the connected probe is adequate with the symbol on the screen and if there is a response on the image when you touch the head of the probe.

7.7. Finishing work

In order to finish work press the power button. When the monitor blanks out it is necessary to carry out cleaning and disinfection of the device according to the recommendations given in the chapter "Maintenance of the device".

If you would like to stop the device working immediately, press and hold the power button until the device turns off.

To protect the probe against damages it should be preserved from falling on the floor.

7.8. Transportation of the device

The aluminum casing of the device is very strong. However, when transporting the device it is necessary to handle it with due care; especially protect the probe and the screen against an impact.

The shipment of the device should be prioritized by thorough protection of the device and its accessories against damage by proper packing of particular elements. The producer recommends shipping the scanner in dedicated case in which it was delivered.

8. Preparation to perform ultrasound examination

Before starting work it is necessary to prepare the device and the accessories.

Switch on the scanner and check if the indicator does not show low battery state (in the case of battery power supply).

Prepare the patient's skin in the in which you want to perform the examination. It is recommended to clip the fur and wipe the skin with a disinfectant – it guarantees antiseptic conditions and degreases the skin.

To perform the examination it is necessary to use a special gel – it is recommended to use medical grade gels dedicated for an ultrasound examination. Always put the gel on patient's skin before attaching the probe.



Warning!

The use of other substances can be dangerous for the patient and may cause adverse effects. It can also have a negative impact on the elements of the probe. Proper use of gel will definitely increase penetration of the beam and will allow obtaining correct and clearer images.

During the examination the below described buttons on the user panel are used to set the best working parameters in particular conditions.

In order to limit the impact of the acoustic energy, emitted by the ultrasound probe, on the operator and on the patient, recommended standards of ultrasound examinations should be followed.

Attention!

Even though ultrasound diagnostics is thought to be a safe method of diagnostic imaging, a harmful level of the working parameters should be avoided. Exceeding the margin of safety can present risk for the operator and the patient.

In this device the range of the parameters regulation is limited by the manufacturer in order to guarantee safety of the user and the patient.

Attention!

Examinations should be performed by qualified and specially trained personnel. It is recommended that the user of the device take part in advanced and specialized courses. Having read the user manual is not sufficient to make a correct diagnosis.

8.1. Patient data

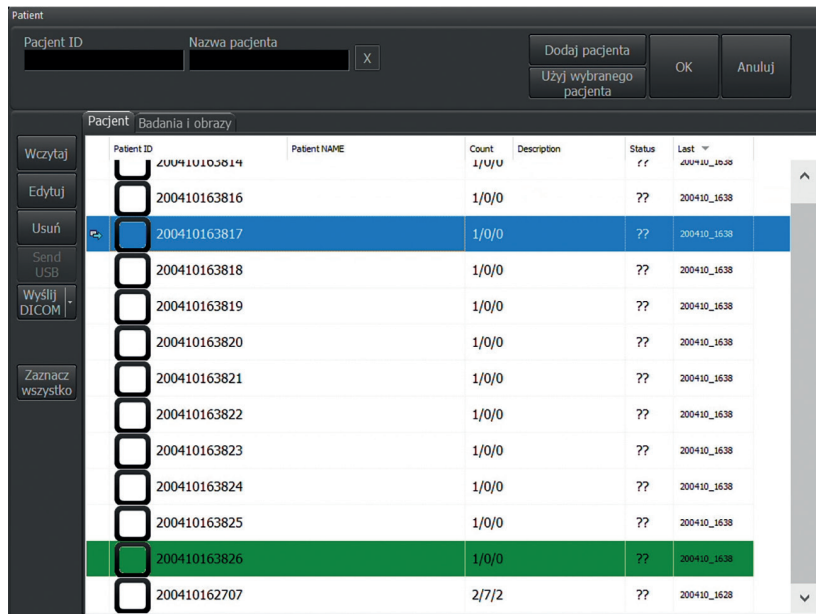

Fig. 12 Database.

8.1.1. Data input

Before starting the examination, enter patient data into the database. Each patient is assigned an individual ID, which, in combination with patient data, allows subsequent studies to be assigned only to them. The user can give a different ID to the patient – in accordance with the rules prevailing in the workplace.

To enter a new patient into the database press [Patient] and select [Browse database].

Complete the [Patient Name] field and press [Add Patient]. Fill in the [Patient Name] field and press [Add Patient]. The patient card will be highlighted in green.

To start the examination press OK.

8.1.2. Selection of a patient from the database

To start examining a patient who already exists in the database, press [Patient] and select [Browse database].

Enter partial data in the [Patient Name] field. The system will filter the patient database as you type. As soon as the patient appears on the list, select his card and press [Use selected patient] to start the examination.

8.1.3. Ending examination

To end the examination, press [Patient] and select [End test]. The system will display the patient database.

9.1.3. Doppler modes: Color Doppler, Power Doppler and Pulse Wave Doppler

To start the Doppler mode tap the [Doppler] button on the mode panel. The Color Doppler mode turns on automatically. To turn Doppler off, press the [Doppler] again.

9.1.3.1. Switching between Color Doppler, Power Doppler and Pulse Wave Doppler modes

After starting Doppler modes additional buttons will appear on the screen (see chapter “User Panel in Color Doppler”). These are used to switch between the modes:

- [Color Doppler] – turns Color Doppler mode on,
- [Power Doppler] – turns Power Doppler mode on,
- [Doppler impulsowy] – turns Pulse Wave Doppler mode on.

9.1.4. Vi-Probe

Vi-Probe mode allows for convex type (virtual convex) imaging on a linear head and sector type (virtual phased array) imaging on a convex head.

Vi-probe can be turned on together with B, B + M and Doppler modes.

Attention! The function works only with selected head models:

- CONVEX HEAD 3.5 MHz R60 mm model AL C1-6/60R,
- CONVEX HEAD 3.5 MHz R50 mm model NDK C2-5 / R50,
- LINEAR HEAD 10 MHz 40 mm model AL 6-14/40,
- MICROCONVEX HEAD 6,5 MHz 15 mm model AL C6/15R.

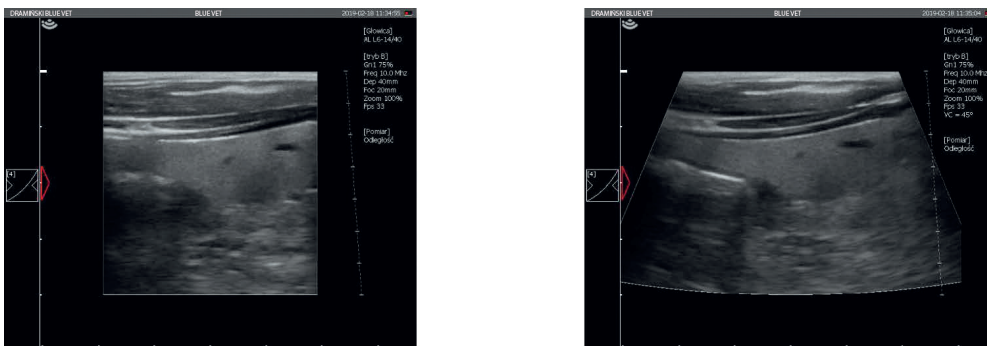

Fig. 14 Vi-Probe: pictures from the linear head. Turned off to the left, turned on to the right.

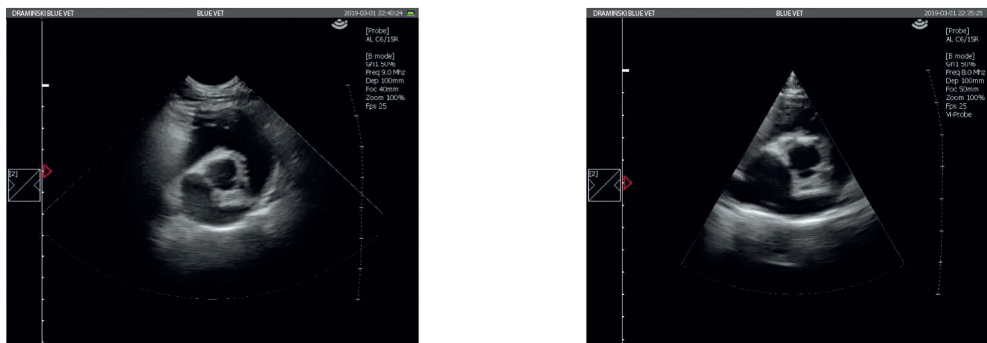
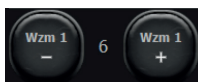

Fig. 15 Vi-Probe: image from the microconvex head. Turned off to the left, turned on to the right.

10. Description of the ultrasound scanner functions

10.1. Optimizing the image parameters

10.1.1. Gain control



[Gain 1] – gain control button

Level of overall gain is indicated by the digit located between the buttons.

There is 8 steps of adjustment. 1 = low gain; 8 = high gain value.

An increase of the gain value results in a brighter image. The gains are changed depending on the user's preference, the kind of examination, the penetration depth and external light conditions.

[Gain 1] can also be adjusted by swiping the finger in the active field which is located at the top of the scanning sector.

10.1.2. Time Gain Control (TGC)



[TGC] – regulacja wzmocnienia strefowego

TGC allows adjusting gain in 8 equal horizontal sections of imaging sector. You can adjust each section separately or choose one of predefined setting.



Marking [Link TGC] bracket causes all the knobs moving together not changing the shape of a TGC curve.

10.1.3. Frequency



The wideband probes which work with the DRAMIŃSKI BLUE Vet can emit beam of different frequencies. Thanks to this function the probes guarantee a wide range of diagnostic capabilities. The higher the ultrasound frequency, the higher the resolution of an image.

The range of frequency depends on the probe type and is available in its technical documentation.

In order to change the frequency you should use the [MHz -] and [MHz +] buttons in the tool panel.

10.1.4. Depth



The depth of scanning is set with the use of the [Depth -] and [Depth +] buttons. The scanning depth is set depending on the position of the examined organs. The penetration range of the beam depends on its frequency – the higher frequency the less depth of penetration.

Additionally, it is possible to change the depth by swiping the finger in the active field at the right edge of the scanning sector.

10.1.5. Focus



These buttons are used to set the focus of the ultrasound beam. The image presented on the screen is the clearest at the level where the beam focuses. The focus level is indicated by a red triangle on the left side of the sector. In order to obtain the best effects it is necessary to set the focus on the depth corresponding to the position of the examined object.

It is possible to adjust the focus using the vertical active field on the left side of the sector.

Additionally the device has an automatic dynamic focus, thanks to which the image is clear in the full range of scanning.

10.1.6. Zoom



This function is used to magnify the image in real time and after freezing. The user has the following zoom levels: 120, 140, 160, 180, 200, 220, 240, 260, 280, 300%. It is also possible to minimize the sector to 60% and 80% of the standard size.

It is possible to set 120% zoom as a default setting. To activate it, please select the required zoom level and enter Settings and mark "Bigger picture" bracket in the Look tab any zoom.

10.1.7. Dynamic range



Dynamic range control.

It allows to adjust how many shades of a greyscale is displayed on an image. Level 1 means the highest dynamic (256 shades of grey), level 10 means the dynamic decreases.

10.1.8. Gamma

Balanced projection of all tones

Various contrast settings

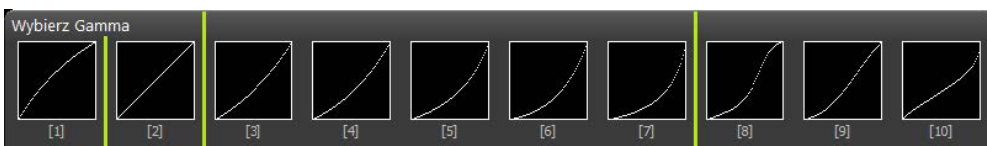

Dominance of light tones

Dominance of dark tones

Fig. Available Gamma settings

Gamma correction enables the change the way in which the greyscale is presented. Correction is possible on an image in real time, after freezing, after loading the saved image or cine loop to the screen.

When you click the [Gamma] button the list of available greyscale settings appears. The selection is made by clicking one of the displayed images. The current greyscale is presented in the form of a bar above the [Gamma] button.

10.1.9. Advanced settings

10.1.9.1. Width of imaging sector

It makes it possible to narrow the imaging sector by excluding the peripheral elements of the head. In a narrower imaging sector, the image can be refreshed more quickly.

To enable, press [Settings] and select one of the items in the [Sector Width] list.

10.1.9.2. Interleaving

Allows you to adjust the number of lines of which the image is composed vertically.

For the settings, Medium is 128, Normal is 256, Strong 384, Very Strong 512 lines.

The higher degree of the interleaving, the higher the resolution but slower the refresh rate.

To enable, press [Settings] and select one of the items in the [Interleaving] list.

10.1.9.3. CI – compound imaging

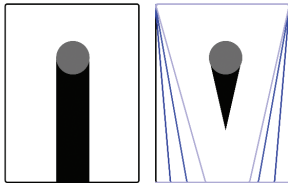

CI (compound imaging) is an imaging method using several ultrasonic bundles falling into structures at different angles. The effect of this function is to reduce the acoustic shadow. The image may consist of 3, 5 or 7 bundles.

To enable press [Settings] and select one of the items in the [CI] list.

Fig. 17 Compound imaging. CI disabled and enabled.

10.1.9.4. Frame averaging

This function results in the display of an image containing data from two adjacent frames. As a result, the image is smoothed and vibrations are mitigated.

To enable, press [Settings] → [Averaging].

To turn off again press [Averaging].

10.1.9. D-Curve

D-Curve is a greyscale curve perfectly matched to the human eye perception.

To enable it tap [B Mode] and mark D-Curve bracket.

To disable tap [B Mode] and unmark the D-Curve bracket.

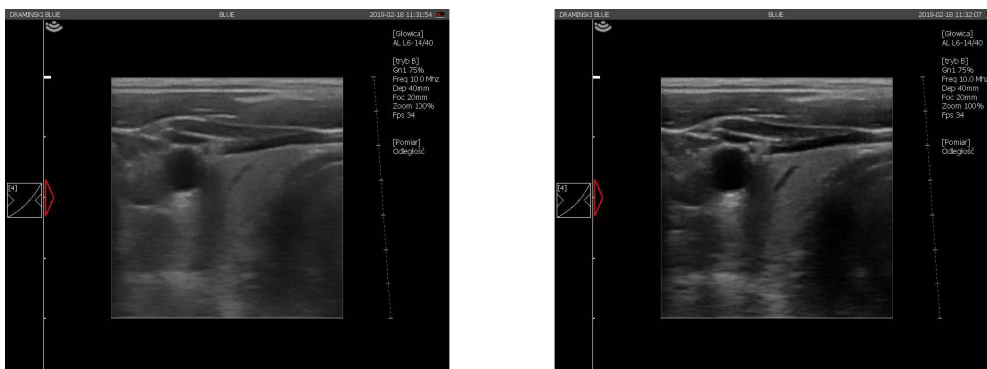

Fig. D-Curve disabled and enabled.

10.1.9.6. Lucid

Lucid is a system that improves contrast, sharpness and tissue reproduction. There are 10 levels to choose from that differ in their characteristics.

The option is enabled by default, and the default Lucid level may be different for different heads.

To change the setting, press [Settings] and select one of the levels that suits you.

To disable press [Settings] → [Lucid].

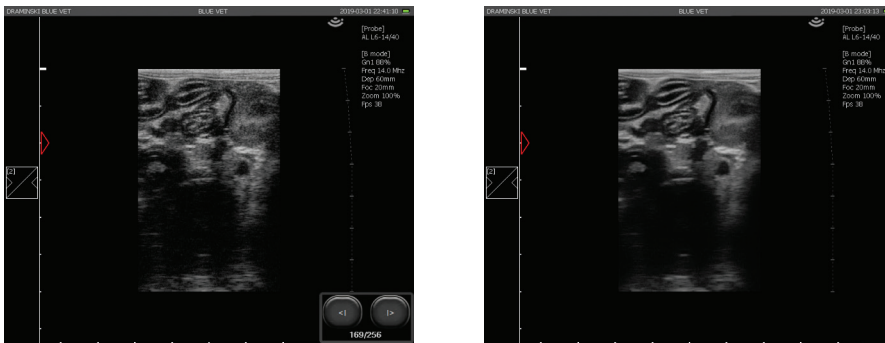

Fig. Example of imaging with the Lucid function off and on.

10.1.9.6.1. Editing the Lucid settings

The Lucid system operates in real time in three image zones – near, focus and far. The strength of the tools can be adjusted for each zone:

Noise – de-noising. Unifies image spots, reducing the effect of digital noise,

Sharpen – sharpening. Highlights the edges of structures,

Contrast – contrast. Adjusts the strength of contrast at the boundaries of structures.

Effect – Intensity of change. Adjusts the intensity of all tools simultaneously for a given zone.

Adjustment of each tool is possible from -16 to +16 degrees.

New settings can be saved using the [Save] button below the editing sliders. Note that changes are saved for a given level of Lucid. If there are presets in the system that use a given Lucid level, the nature of the image in those presets will change.

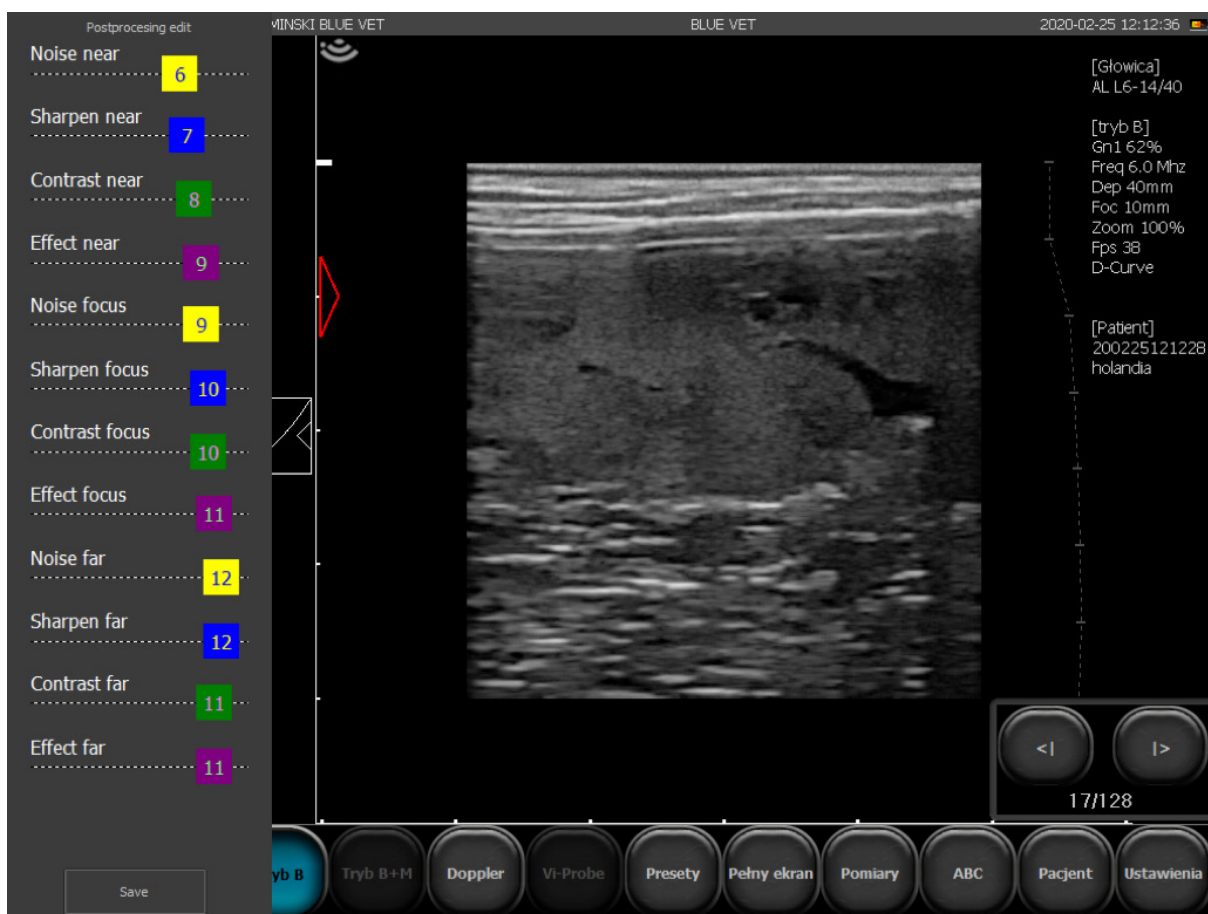

Fig. Adjusting the Lucid settings.

10.2. Freeze



To freeze the image, use the [Freeze] button. When you press this button the image immediately freezes and the button changes its color. In order to unfreeze the image and return to scanning mode you should press the [Freeze] button again.

10.3. Cine loop – continuous and frame-by-frame replay



When the image is frozen a set of buttons appears in the right bottom corner of the screen. These buttons are dedicated to manage the cine loop. Each loop can consist of 512 frames maximum.

In order to play the cine loop press and hold the [I>] button. Viewing the cine loop frame by frame is possible by tapping the [I>] button.

In order to playback or rewind the cine loop by frame, press [<I] and hold.

10.4. Measurements

Attention! Measuring rules in Pulse Wave Doppler mode were described in <10.8.4. >.

On the left side of the imaging sector there is a scale with 1 cm calibration which enables understanding the dimensions of the examined structures in real time.

When you freeze the image the distance measurement is enabled automatically.

The presented object can be measured by other methods as well. They are available when you click the [Measure] button on the mode panel.

Dimensioning tools:

1. **[Grid]** – approximate measuring on the basis of the grid placed on the object (its resolution is 1 cm).
2. **[Stenosis]** – determines the stenosis given in percent.
3. **[Volume]** – volume (calculated from 3 measurements).
4. **[Length]** – measuring the distance between the indicators.
5. **[Area]** – measuring the area of the examined object of any shape.
6. **[Ellipse area]** – measuring the area by laying the ellipse.
7. **[Follicle]** – automatic determination of the largest dimension between follicle walls.
8. **[OB/GYN]** – Obstetrics package: ICC queen, ICC small bitch, ICC medium bitch, ICC large bitch, ICC giant bitch, BP queen, BP small bitch, BP medium bitch, BP large bitch, BP giant bitch, Vesicle diameter Horse Equine BPD, Equine ED, Equine VD.
9. **[Cardiology]** – set of measurements used to assess the heart function: number of beats per minute (HR), Teichholz method left ventricular (LV) function.
10. **[Clear]** – clears the screen from the measuring elements.

10.4.1. Length

It is the most frequently used method of measuring. When you freeze the image, the distance measuring option switches on automatically. You can perform 5 different measures on one image.

When you press point A and then point B the ruler appears which connects both points and the number determining this measuring.

You can use a magnifier to make measuring of small structures easier, it appears when you press and hold the finger longer on the screen. This function enables a precise location of the measuring point without getting the finger off from the screen. When you take the finger off the magnifier disappears, this enables marking the second point.

Results are shown in sequence in the left bottom corner of image. The measures are given in mm with the precision of up to 0.1 mm.

10.4.2. Grid.

To show the Grid from the Measure menu. The window appears in which you can select the grid. When you select this option on the imaging sector the grid will be placed on the image (the scale is 1 cm).

To change the color of the grid, press on the color selection box. Select a color from the palette and confirm OK.

To change the intensity of the grid color, set the value on a scale of 20–100%.

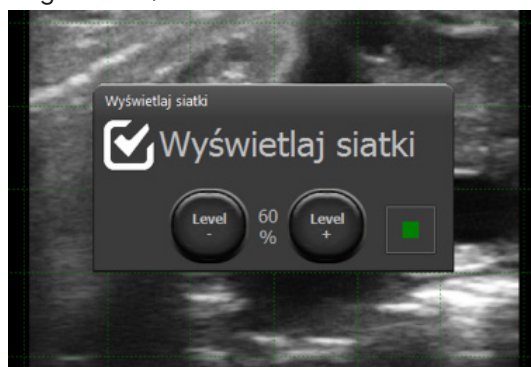

Fig. Measurement grid settings.

10.4.3. Stenosis

In order to determine the stenosis it is necessary to obtain the lengthwise section of the narrowing object. Then you should take two measures in its diametrical planes. The result is given automatically in percent. This option is used, for example, when evaluating blood vessels.

10.4.4. Volume

In order to measure the volume correctly it is necessary to measure the length, depth and width of the object. For this purpose you should obtain sections in horizontal and vertical planes. In order to obtain two planes in one image you can use B+B mode. The device automatically calculates the volume of the object taking into account the performed measurements. The result is presented in cm³.

10.4.5. Area

To measure the area you should outline the object on the touch panel without taking off the stylus or the finger until you finish the loop. In order to finish the outline you should click into the point from which you started drawing the line. The result is given in sq. cm and is shown below the image sector.

10.4.6. The area of ellipse

Mark long axis of ellipse by applying two points on an image. Third point apply on one of the poles of short axis of the measured object. The result is given in sq. cm and is shown below the image sector.

10.4.7. Follicle

Automatic follicle measurement makes it easy to find the largest dimension between the walls.

Press on the center of the follicle and the system contours the circumference of the follicle on the inside of the wall and automatically determines the largest dimension.

The measurement result can be modified by changing the sensitivity threshold. The sensitivity threshold (Thr.) determines what level of echogenicity of the structures should be the boundaries for the contour.

10.4.8. OB/Gyn

To perform OB/Gyn measurement, enter [Measurements] and tap [OB./GYN].

10.4.8.1. ICC (Inner Chorionic Cavity)

Apply two distances perpendicular to each other in place where the diameter of the cavity is the largest. It is important to put the measurement points at the inner site of the cavity wall. The best results are achieved when many foetus are measured and a mean value is calculated.

There are different calculating formulas for different size and species of animals. The result is given in days.

The ICC measurement is available in the version for bitches and queens:

measurement	body weight	type of measurement	result / formula	margin of error
ICC Small size bitch	< 10kg	piecemeal	ICC = mm; DBP = (mm-68,68)/1,53	+/-2 days
ICC Medium size bitch	10-25 kg	piecemeal	ICC = mm; DBP = (mm-82,13)/1,8	+/-2 days
ICC Large size bitch	25-40 kg	piecemeal	ICC = mm; DBP = (mm-105,1)/2,5	+/-2 days
ICC Giant size bitch	>40 kg	piecemeal	ICC = mm; DBP = (mm-88,1)/1,9	+/-2 days
ICC Queen	bd	piecemeal	ICC = mm; DBP = (mm-62,03)/1,1	+/-2 dni

10.4.8.2. BPD (Biparietal diameter)

Get the view of longitudinal section of the fetal head with a two parietal bones parallel to each other. Mark the distance between the bones.

The best results are achieved when many fetuses are measured and a mean value is calculated.

There are different calculating formulas for different size and species of animals. The result is given in days

measurement	body weight	type of measurement	result / formula	margin of error
BP Small size bitch	< 10kg	piecemeal	BP = mm; DBP = (mm-25,11)/0,61	+/-2 days
BP Medium size bitch	10-25 kg	piecemeal	BP = mm; DBP = (mm-29,18)/0,7	+/-2 days
BP Large size bitch	25-40 kg	piecemeal	BP = mm; DBP = (mm-30)/0,8	+/-2 days
BP Giant size bitch	>40 kg	piecemeal	BP = mm; DBP = (mm-29)/0,7	+/-2 days
BP Queen	bd	piecemeal	BP = mm; DBP = (mm-23,39)/0,47	+/-2 days

* Determination of gestational time and prediction of parturition in dogs and cats: an update M. Beccaglia | S. Alonge | C. Trovo' | G. C. Luvoni

10.4.8.3. Equine BPD Measurement

Biparietal measurement for horses (Biparietal Diameter).

To properly measure BPD, obtain a symmetrical cross-section of the head in the frontal plane showing both parietal bones and the spine. Measure the distance between the outermost ends of the parietal bones. The tool is designed to estimate the age of the fetus between 100 and 330 days.

10.4.8.4. Equine ED

Measurement of the eyeball (Eye Diameter).

To measure, visualize the fetal eyeball in cross-section. Measure the distance between the medial and lateral walls of the eyeball. The tool is designed to estimate fetal age in the range of 65 to 356 days (taking into account the limit of error).

10.4.8.5. Equine VD

Vesicle Diameter measurement.

To measure correctly, find the widest section through the embryonic vesicle. Set the measurement points at the border of the bubble wall and lumen.

The tool is designed to estimate the age of the fetus in the range of 13 - 45 days.

10.4.9. Cardiology

10.4.9.1. HR (Heart rate)

Measurement to be performed in M Mode.

Put the distance between the two full cycles of heart function.

Heart beat per minute will be calculated automatically. Result is given in b/min.

10.4.9.2. LA/Ao (Left Atrium to Aorta diameter ratio).

Apply two distance on an image:

1. Left Atrium diameter (in systole)
2. Aorta diameter (in systole)

LA/Ao ratio is calculated automatically. Result is given in %.

10.4.9.3. LV (Left Ventricle function)

This measurement allows to calculate:

- EDV (end-diastolic left ventricle volume),
- ESV (end-systolic left ventricle volume),
- SF (Shortening Fraction),
- EF (Ejection Fraction).

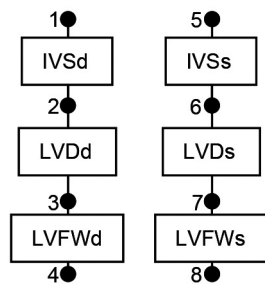

Fig. 19. Sequence of marking the measurement points while measuring the parameters of the left ventricle.

Measurement to be performed in M Mode.

Freeze an image showing full heart function cycle and follow the steps below:

1. Find the place in which the diameter of the left ventricle is largest in diastole.
2. Apply the measuring points :
 - at the border between right ventricle and the septum,
 - at the border between left ventricle and the septum,
 - at the border between left ventricle and the left ventricle free wall,
 - at the outer edge of the left ventricle free wall.
3. Next, find the place in which the diameter of the left ventricle is smallest in systole.
4. Apply the measuring points marking the same structures as in step 2.

System will automatically measure: Inter-Ventricular Septum in diastole and systole (IVSd, IVSs), Left Ventricle Diameter in Diastole and systole (LVDd, LVDs), Left Ventricle Free Wall in diastole and systole (LVFWd, LVFWs), and calculate EDV, ESV, SF and EF.

Formula for EDV: $EDV = (7 \times LVIDd^3) / (2,4 + LVIDd)$.

Formula for ESV: $ESV = (7 \times LVIDs^3) / (2,4 + LVIDs)$.

Result is given in ml.

10.4.9.4. Left Ventricle Volume – Simpson’s LVAM–LVAP method

Measurement to be performed in 4B Mode.

Get three views in three different windows in 4B Mode:

1. Left Ventricle in long axis,
2. Left Ventricle in short axis at the level of Mitral Valve,
3. Left Ventricle in short axis at the level of Papillary Muscles.

Apply distance measurement on an image of left ventricle in long axis (LVL). Apply area ellipse measurement on ventricle image at the level of Mitral Valve (LVAM) and at the level of Papillary Muscles (LVAP).

Result is calculated on basis of formula: $V = (LVL / 3) \times (LVAM + (LVAM+LVAP)/2 + LVAP/3)$; and given in ml.

10.4.9.5. Left Ventricle Volume – Simpson’s single plane method

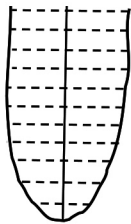

Get the left side four chamber view.

Outline the left ventricle beginning and finishing at the mitral valve level.

The system will automatically mark long axis and lines parallel to the base of a left ventricle.

The Result is given in ml.

Fig. 20. Outlined area of the left ventricle

10.4.9.6. Left Ventricle Volume – Bullet’s method

Measurement to be performed in 2B Mode.

Get two views in three different windows in 2B Mode:

1. Left Ventricle in long axis,
2. Left Ventricle in short axis at the level of Mitral Valve.

Apply distance measurement on an image of left ventricle in long axis (LVL) and area ellipse measurement on ventricle image at the level of Mitral Valve (LVAM).

Result is calculated on basis of formula: $V = (5 / 6) \times LVL \times LVAM$; and given in ml.

10.4.10. Edition of the measurements

The user can change the positions of the measuring points.

While marking the points the window with navigation buttons appears in the top left corner of the screen. Editable measuring line is marked with yellow color.

Using the direction buttons it is possible to change the position of the point marked by a red cross. In order to change to the other measuring point it is necessary to use A/B keys.

If you would like to switch on the magnifier, press [Magn.]

In order to delete one measurement you should use the [Del.] key. After performing this operation the previously made measurement becomes active.

If you would like to deactivate the navigation buttons, click [X].

The measurement editing panel can be moved at any position on the screen by "catching" its middle with the finger.

10.4.11. Deleting all the measurements

When you press the [Clear] button in [Measurements], all the elements of the measuring and the results will be deleted from the screen.

Deleting the elements of the measuring also takes place after unfreezing the image in B mode or switching to B mode from other modes.

10.5. Annotations and description of the series of images

Use the ABC annotation to describe a specific structure in the image.

To describe a series of images in the same way, such as by specifying the location of the study, use the description of the image series.

10.5.1. ABC Annotations

In order to add an annotation, freeze the image and press [ABC].

Touch the screen where the structure you want to describe is shown. A keyboard and a text box with a selection list will appear on the screen. Enter a description in the text field or select a description from the list. Repeat the activity for each description separately.

If you want to add the entered annotation to the list of ready annotations, press +.

If you want to remove an annotation from the list of ready annotations, select it and press "-".

If you want to change the point to an arrow, expand the list to the left of the annotation line.

To change the position of the description, drag the description with your finger to another location. The keypad disappears when the description is repositioned.

To save the annotated image, turn off the keyboard with the "x" button in the upper right corner and press Save Image.

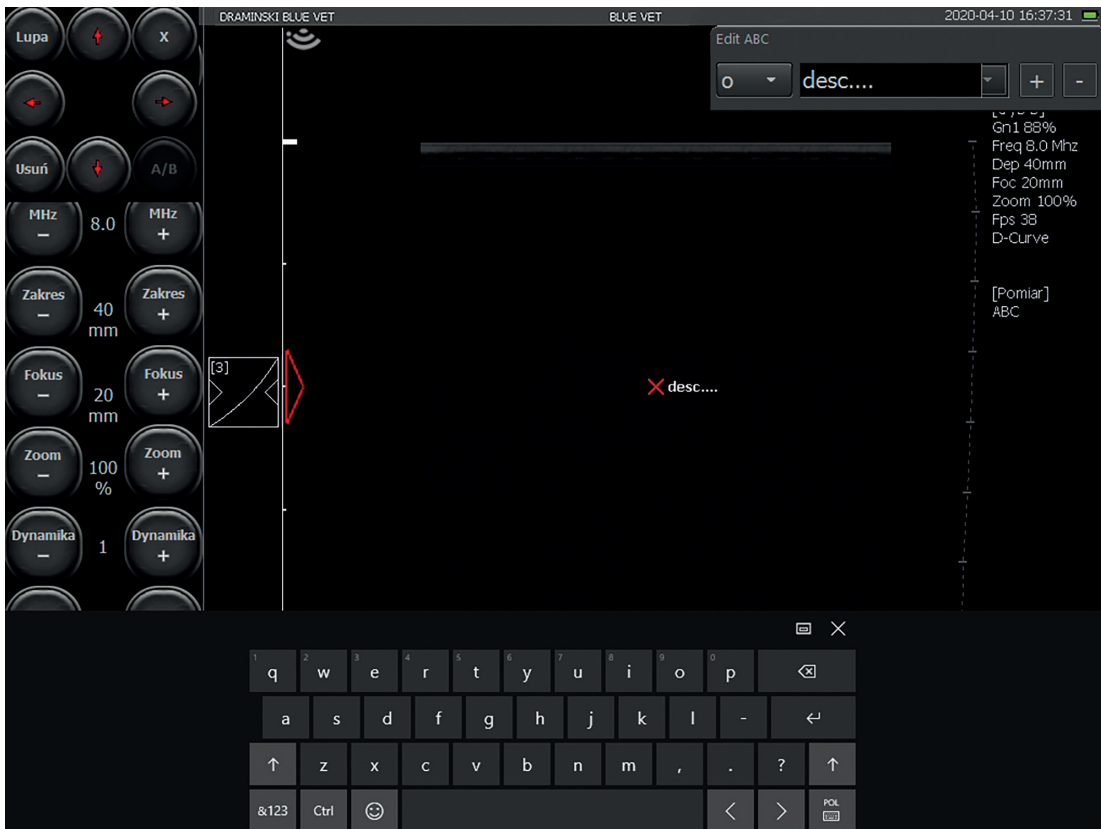

Fig. 21 Add annotation window.

10.5.1.1 Exporting and editing the ABC annotation list

You can save a list of existing annotations in a text file in external memory. This will be helpful when editing the annotation list. The file created is in .txt format supported by Windows.

To export the ABC annotation list:

1. Connect the flash drive and mouse to the USB ports of the ultrasound machine
2. Press [ABC]
3. Hover over the description text box and press the right mouse button.
4. Options to choose from will appear. Press [Export list to file].
5. Wait for the message “Export OK” to appear.

To edit the exported list of ABC annotations:

1. Connect the flash drive to a Windows computer
2. Find and open the file “notes.txt”
3. Add or delete descriptions from the list. Remember that each description must be placed on a separate line.
4. Save the changes and close the file.

10.5.1.2 Importing the ABC annotation list

You can import your own list of annotations. Remember that when importing, the original file is overwritten by the imported file. If you want to keep existing annotations in the system, first export the list of annotations and create a new one based on it.

To import a list of ABC annotations:

1. Connect the flash drive containing the annotation list in the “notes.txt” file to the USB port of the ultrasound scanner. Important! The file “notes.txt” must not be placed in any folder.
2. Connect the mouse to the USB port
3. Press [ABC]
4. Hover over the description text box and press the right mouse button.
5. Options to choose from will appear. Press [Import list from file].
6. Wait for the “Import OK” message to appear.

10.5.2. Description of the series of imagesw

If you plan to record a series of images, such as for the right front limb, you can enter a description that will be added automatically to each image until you turn it off or change it.

To add a description for a series of images, press [Patient] and select [Image description].

Enter a description in the text box or select from the list.

Check the [Automatic add image description] box and press the screen anywhere.

The description will be displayed in the lower left corner of the imaging sector. From now on, it will be automatically added to every saved image and cine loop.

To turn off the description for a series of images, press [Patient], select [Image description] and uncheck the [Automatic add image description] box.

10.6. Optimization of B+M and M modes

10.6.1. Graph drawing speed selection in M mode

In order to activate B+M mode press [B+M Mode] button. The submenu will appear over the button, where you can select graph drawing speed in M mode. Available values: 1s, 2s, 3s, 4s.

10.6.2. Setting the sampling line in B+M / M modes

Setting the sampling line is based on B mode image. In order to change its position drag and drop it with your finger.

10.6.3. Switching between M and B+M modes

After pressing [B+M mode] button new submenu will appear, where on the top there is [M/B+M] button. It is used for switching between B+M and M modes.

10.7. Imaging with the function of color Doppler

The Color Doppler functions allow viewing a blood flow in a real time together with B Mode image in the background. The blood flow is coded by the color depending on its direction. The red color corresponds to the blood flowing to the head of the probe. Blue color means the reverse direction.

Attention! By double click in color bar the reverse colors option is activated (stream flowing to the head of the probe will be coded with blue color, red color means the reverse direction).

10.7.1. Starting Color Doppler imaging

Remember that preparing the correct preparation a patient for examination has great influence on results. Use of an appropriate amount of gel is essential for obtaining a good result.

Before starting the Doppler function you should find the clearest image of the organ in B-Mode, showing the vessels. The image in B-Mode too high Gamma and Gain setting will have a negative influence on the quality of the Doppler image.

In order to start this mode you should click [Doppler] button in the mode panel.

The screen will show the active panel managing the Color Doppler function and Doppler frame.

10.7.2. Switching between the Doppler modes: Color, Power, Pulse Wave; Doppler mode OFF

To switch between the Doppler modes use [Color Doppler], [Power Doppler] and [Pulse Doppler] buttons. They are visible under the [Gamma] button after pressing [Doppler] button.

In order to finish work in Doppler mode press [Doppler] button again. The device will automatically return to the B Mode.



Color Doppler = the Doppler with color coding of the blood vessel flow



Power Doppler = the Doppler with coding the power of the flow

Pulse Doppler = the Doppler used to measure the flow speed

10.7.3. Doppler frame settings

The frame superimposed on the test sector has a shape depending on the head used. For head type:

– convex – the frame resembles a trapezoid ,

– linear – the frame has a rectangular  shape (rhombus  for an angle of inclination different from 0°).

10.7.3.1. Repositioning of the color box

When you touch the color box it changes its color to green and the navigation icon appears in the middle. To move the color box, touch the navigation icon and drag it with your finger.

10.7.3.2. Resizing of the color box

After you touch the color box, the 4 knobs appear on each corner. Drag one of the knobs to change the size of the box.

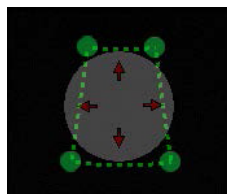

Fig. Resizing the color box.

10.7.3.3. Steering angle of the color box

In the case of using linear probes it is important to apply the probe at the angle towards the vessel. The flows in the vessels perpendicular to the ultrasound beam would not be registered (it follows from Doppler effect $\rightarrow \cos 90^\circ = 0$). In order to facilitate the imaging of the flow in the examined vessel the user can correct the steering angle of the color box in the range of $\pm 15^\circ$. For beginners the recommended angle is max. 10° . This function is used in long axis views.

In order to do it use [Angle -] / [Angle +] buttons in color doppler mode.

10.7.4. Setting parameters for the Doppler mode

10.7.4.1. [PRF] – Pulse Repetition Frequency

The PRF setting depends on the speed of the flow. In order to depict fast flows you should set a higher PRF value. When the PRF increases the refresh rate also increases.

In order to depict the blood which flows with a slow speed you should set a lower PRF value. The refresh rate in this case decreases – black-and-white clear motion rate can also decrease.

Thus, when you examine small vessels with low flow rates you should minimize the PRF value. Otherwise it will not be possible to depict the flow in these vessels.

10.7.4.2. Doppler Frequency

It is set alike to the MHz frequency of the black-and-white image. The deeper the examined structure the lower frequency you should set.

Attention! Doppler frequency settings do not influence probe frequency settings in B mode.

10.7.4.3. Color gain adjustment

It is necessary to set so high level that there are no "holes" in the colors filling the vessel, and at the same time so low that the color does not "overflows" the vessels.

The range is from 1 to 10 steps.

10.7.4.4. Frames averaging

This function allows averaging the number of the depicted frames coded by the color. The increase of the value causes the decrease of the number of artifacts, but can cause worse vessels filling.

When you examine small vessels the parameter of frame averaging should be set to 1. It will make monitoring the flow easier. At higher values the imaging in these vessels would be limited.

10.7.4.5. [Wall filter]

High-pass filter. Increasing the value means that the color caused by tissue motion will not be displayed – reduction of motion artifacts.

Attention! At the same time, data from free flows can be filtered out!

10.7.4.6. [FPS quality]

The FPS / Quality priority allows you to decide whether you want the color image to refresh faster or be displayed in better quality. A low value means faster refresh rates and lower color resolution. A high value means slower refresh rates and higher color resolution.

10.7.4.7. Color invert

Double clicking the color bar (Fig 13, no. 1) activates the function of color reversal (the flow towards the head will be coded by the blue color and in the reverse direction by the red color).

10.7.4.8. Color Threshold

Press the color bar (the color threshold modification window appears). This function enables ignoring the small speed flows in the depicted image (coded with a darker color). When the color threshold increases the image will depict only the flows coded by the color typical for the higher speeds.

10.7.4.9. [Color Range]

Press on color bar (color range modification window appears). This function enables imaging a specified range of speeds in a wider color range. This the maximal speed is determined (depends on the probe type) which will be coded by the brightest color.

It should be remembered that a proper preparation the patient for the examination has a huge impact on the test response. A too thin layer of ultrasound gel on the skin can make the test difficult.

10.8. Power Doppler

In the Power Doppler mode the device sums the flows in a particular place and shows in the picture general vascularization of the organ without showing the speed and direction of the flow.

Thanks to this function it is possible to show the vascularization of the organ depicting even very slow flows.

10.8.1. Power Doppler settings

Basic parameters (PRF, frequency, gain, tilt angle frame, color threshold, color range and wall filter) can be set alike in the Color Doppler mode.

10.8.1.1. Postprocessing

This function is used for smoothing the map of colors for the Power Doppler mode.

[Mode -] button disables image processing, whereas [Mode +] button enables it.

10.8.1.2. Filtered / Not filtered averaging

This function enables displaying average data collected from previous frames – with enabled or disabled color postprocessing.

Other buttons and functions are the same as in the Color Doppler mode.

10.9. Pulse Wave Doppler

The Pulse Wave Doppler function enables measuring the blood flow speed in a selected vessel.

In order to switch on this function you should go to Doppler mode and then press [Pulse Doppler] button.

10.9.1. Pulse Wave Doppler settings

For the best results it is necessary to obtain the sharpest angle to the vessel.

In Color Doppler mode set the test parameters so that to obtain the optimal Doppler spectrum. The examined vessel should be visible in a large part of the screen.

10.9.1.1. Gain

Enables amplification of the signal.

10.9.1.2. Sampling gate depth

Sampling gate should be set to coincide with the flow spectrum.

[Depth -] and [Depth +] buttons can be used to move the gate up and down along sampling line of color box. You can also drag whole color box with your finger and the sampling gate will follow.

10.9.1.3. Insonation Angle

Set the insonation angle using a slider if possible in parallel to the direction of blood flow. The insonation angle is marked with the green line.

Remember that exceeding 60° will significantly increase the possibility of wrong result!

10.9.2. Registration of blood flow spectrum

In order to register the hemodynamic parameters you should press [Gate enable] button.

A leading line will appear at the bottom window, and then a diagram of hemodynamic blood parameters will appear. At this stage it is important to hold the probe in the initial position.

10.9.3. Modification of baseline position

The user can modify the baseline position during a spectrum registration.

In order to change the baseline position press it and hold until it turns green and then drag it up or down on the screen.

[Scope] – allows correction of the depth of the sampling gate position in case the head position has changed during the measurement. After changing the depth, the device will calculate the parameters according to the previously recorded spectrum, and the leading line will determine the new graph;

[REINFOR.] – makes it possible to reinforce the signal;

[Flip] – Changing the orientation of the spectral plot with respect to the baseline;

10.10. Measurement in the Color Doppler and Pulse Wave Doppler mode

10.10.1. Measurement of blood supply area [Flow Area] (Color Doppler)

Measurement available in Color Doppler and Power Doppler modes.

Allows estimation of the ratio of color-coded image area to black-and-white image area within the Doppler frame. The tool helps to estimate the extent of organ bleeding.

Freeze the image in the Color Doppler mode. Select [Measurements] → [Flow Area]. The device will calculate the area of the color-coded area and give the result in % relative to the area of the black-and-white image.

10.10.1.1. [HR] – Heart Rate (Pulse Wave Doppler)

Put two markers on the spectrum graph selecting two full heart cycles.

Results will be given in bpm.

10.10.1.2. [AT] – acceleration time

Put two markers on the spectrum graph:

- the first one in the place where the blood flow velocity value in the final phase of diastole is the lowest,
- the second one in the place where the blood flow velocity is the highest.

Results will be given in seconds.

10.10.1.3. [RI PI PSV EDV]

Calculate PSV (peak systolic velocity), end-diastolic velocity (EDV), average velocity (AVG), pulsation index (PI), resistance index (RI) at a particular section.

Put two markers on the spectrum graph:

- the first one in the place where the blood flow velocity is the highest.,
- the second one in the place where the blood flow velocity value in the final phase of diastole is the lowest.

The device will automatically calculate above values.

10.10.1.4. [Doppler Point]

Calculates the flow velocity at any point.

10.11. Saving and loading the images and cine loops

This function allows saving the frozen images and cine loops to the internal memory of the device. You can add the patient's data and the case description.

Attention! Remember to export saved images and cine loops to external memory and clear the device's memory systematically.

10.11.1. Saving the image

Freeze the image with the [Freeze] button. After freezing the image in the camera cache is the last 128-512 frames of examination. Use the arrows in the lower right corner to select a frame to save and press [Save Image]. Defreeze the image with [Freeze] to continue the examination.

If you did not enter patient data into the database before the examination, the system will ask you to create a new patient card. You can enter patient data or create a card with an automatically generated ID by pressing [Add Patient]. To continue the examination, press [OK].

To enter patient data prior to testing, use the Patient function.

When saving the image to the machine's memory, you can print it at the same time using the [Print] function. Printing is possible after downloading the drivers and connecting the printer.

10.11.2. Saving the Cine loop

After freezing the image, the ultrasound scanner has a cache loop consisting of 128-512 last frames of the examination. To save it, press [Save Cine]. Defreeze the image with [Freeze] to continue the examination.

10.11.3. Restoring patient examination

Use the arrows at the top of the screen to browse between images and video loops of the examination.

In order to load the image saved in the device click [Open Image] button. The screen will show a list of the saved images. Select particular image by clicking it (it becomes highlighted) and then click [Load]. You can load one image at a time.

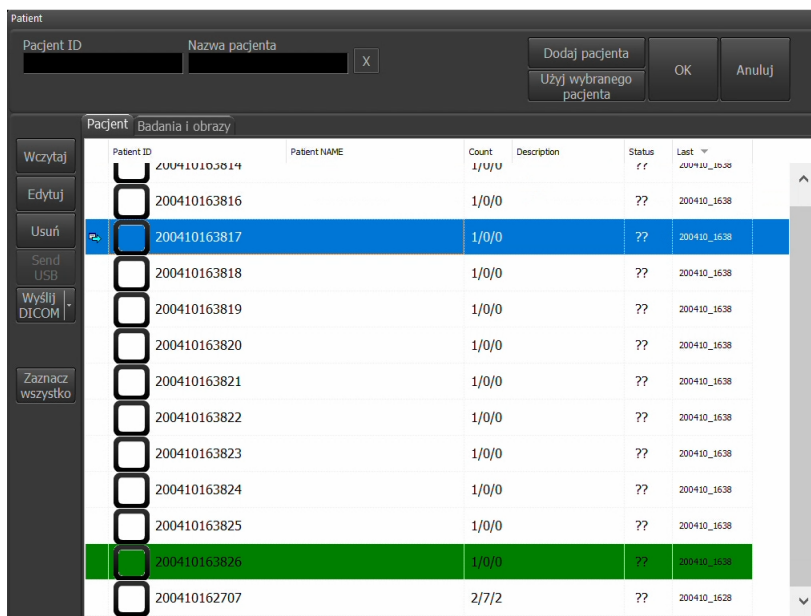

Fig. Data base.

10.11.4. Editing the patient's data

You can edit the patient's name and ID, as well as add the date of birth, sex and description to the entire examination or individual images / video loops.

To edit data, select chosen examination, image / video loop and click [Edit]. Fill in the appropriate fields and click [Save] to save or [Cancel] to discard changes.

10.12. Exporting data to external storage media

You can export data to external storage devices. Images are exported in PNG format, and video loops in AVI, MOV or MP4. In addition, all data can be exported to storage device in a format compatible with the DICOM 3.0 standard. < 11.8.3. >

To transfer data, connect the storage device to the USB socket. Then click [Open] to display the database. Input patient data to filter his card from the list.

- if you want to export all patient examinations, select the checkbox on the patient card.
- if you want to export a single examination, go to the [Examinations and images] tab and select them on the list.
- if you want to export selected images / video loops from a given examination, go to the [Examinations and images] tab, double-click the examination to expand the list of files, and select the appropriate images / video loops.

To export the marked data, press [Send USB]. A window will appear showing the progress of the process.

Once the transfer is complete, a window will appear with a selection of options:

- [Close] – closes the window, but does not disconnect the external memory, so you will be able to continue losing data;
- [Close and disconnect] – closes the window and safely disconnects the external memory from the system.

When exporting files, the system creates a BF32_save folder on the portable drive, and in it a folder with the export date. Separate folders are then created for exported images and video loops.

10.13. Exporting data in DICOM format

Attention! Make sure the ultrasound scanner is properly connected to the facility's internal network or the Internet using a LAN cable or an external WiFi antenna (accessory).

Attention! Make sure the data server is properly configured <11.8.1.>.

Send data in DICOM format to the server, click [Open] to display the database. Input patient data to filter his card from the list.

- if you want to export all patient examinations, select the checkbox on the patient card.
- if you want to export a single examination, go to the [Examinations and images] tab and select them on the list.
- if you want to export selected images / video loops from a given examination, go to the [Examinations and images] tab, double-click the examination to expand the list of files, and select the appropriate images / video loops.

To export the marked data, press [Send DICOM]. The screen will show the progress of the process.

If more servers are configured in the system, expand the list by pressing the arrow on the [Send DICOM] key and select the appropriate server.

Due to the large amount of data sent, we suggest that you plan this activity at the end of your work day.

10.14. Image printing

In order to print images it is necessary to install printer drivers first.

There are drivers for Mitsubishi P95D printer already installed in the screen.

In case of multiple printers working with the device, select a printer from the list before starting the work. Go to [Settings] -> [Info] -> expand the list of printers.

10.14.1. Printing during examination

In order to print an image during examination, press [Freeze] to freeze it and then click [Print].

In the right bottom corner a print preview window will appear with the image miniature and [Print] and [Clear] buttons.

Press [Print] button in the print preview window to print the image or [Clear] button to exit.

10.14.2. Printing of stored images

In order to print images stored in the internal memory, load it to the screen and press [Print].

In the right bottom corner a print preview window will appear with the image miniature and [Print] and [Clear] buttons.

Press [Print] button in a print preview window to print the image or [Clear] button to exit.

10.14.3. Printing multiple images on one sheet

The user can print up to 4 images on one sheet.

In order to print more than one image follow the below steps:

Freeze the image -> press [Print] -> unfreeze the image and continue examination -> freeze image -> press [Print]...

Repeat this sequence of steps until proper image quantity appears in the print preview window. Next press [Print] button in the print preview window.

10.15. Fullscreen

It is used to hide a user panel and mode panel, the sector of examination spreads on the entire screen.

In the full screen mode the user can use:

- active fields: gain, focus and scanning depth,
- gamma settings
- image freezing,
- image and cine loop saving,
- measurements.

10.16. Presets

Presets are predefined settings of the scanning parameters dedicated to different kinds of examinations.

10.16.1. Presets activation

Standard presets are: COW OVARY, DOG CARDIO, DOG S ABDOMINAL, DOG M ABDOMINAL, HORSE SDFT, HORSE DDFT, HORSE FOOT.

Presets are assigned to the type of head, so that not all of them are visible on the list at once.

imaging sector width, interleaving, compound imaging.

In order to activate a required preset, click [Presets]. The list of available presets will appear. Select a preset name to activate it.

It is possible to activate a preset from Manage Presets window by clicking [Load preset] button.

10.16.2. Presets saving

This option allows saving your favorite settings of the device using a user name. It can also be used to save the settings optimal to examine a particular organ.

Parameters which may be saved as preset are:

1. For the black and white imaging – Gain, TGC, Frequency, Depth, Focus, Zoom, Gamma, Dynamic Range, LuciD, Vi-Probe.
2. For the Doppler imaging – PRF, Frequency, Gain, Frames averaging, Wall Filter, FPS / Quality.
3. For additional settings – Frames averaging, image invert (right/left, up/down).

In order to add a new preset you should optimize the settings first. Then click the [Presets] and choose the [Manage presets] option. A dialogue box appears which is used to add, delete, edit and turn on the presets.

On the right side of the box current setting of the device appears to be saved. In order to save it choose option [New preset]. The box to write the preset name appears. After filling the field press [OK]. The preset will be saved and appear on the list in the preset managing box.

In order to delete the preset open the preset managing box and select the preset by clicking its name. The name highlights. Then select the [Delete preset] option.

11. Advanced settings

In order to enter the advanced settings menu you should click the [Settings] button. The advanced settings consist of tabs described below.

11.1. Default

In the [Default] tab there are tools for modifying the user panel.

The options available:

- changing the position of the tool panel from left to right of the screen,
- up-down, right-left image orientation changes. Change of image orientation is signaled by moving the indicator corresponding to the marker on the head.
- showing / hiding the mouse cursor,
- needle track display for OPU (accessories required)
- beamformer, processor and motherboard temperature display in the information window,
- larger image – setting a larger sector size as the default,
- system language changes,
- head selection,
- background color changes,
- selection of the software's graphic theme.

11.2. Clinic

In the section /Clinic/ the user can type the name of their clinic or doctor's name. The name will appear on the upper information bar above the sector of examination.

11.3. Info

In the /Info/ section the user can check the software and device version, the software license number, the scanner's IP and battery information.

Beside this the user can:

- update the software,
- select a printer from the list of available printers,
- select the style of the exported file name,
- select the format of exported cine loops (AVI, MP4, MOV),
- restore the factory settings,
- turn on and off the operating system protection,
- restart the ultrasound scanner system.

11.3.1. Software update

There are two ways to update the software:

- On-line,
- Via a USB flash drive.

Attention! Before the software update it is necessary to check current device version. This information can be found in the /Information/ section on the right. Each new software version is strictly correlated with the device version. You should make sure that a new software version is compatible with your device version.

11.3.1.1. On-line update.

To update the software via the Internet, connect the LAN cable to the camera socket or the WiFi antenna to the USB Socket < 11.9.1. >.

In order to update software via Internet connect the LAN cable to the appropriate socket. Next enter [Settings] and choose /Info/ tab.

Press [Update over Internet]. New message box will appear. Click [Next]. The update will start. New software will install automatically. Wait until the system restart.

If the device doesn't start to download the update files, please check your Internet connection.

11.3.1.2. Update using a USB flash drive.

In order to update the software via a USB flash drive please contact a DRAMINSKI Representative to acquire the file with the newest software version. The installation file should be called "update_blue.7z".

Create a "update_blue" folder on the flash drive. Copy a received software update file to this folder.

Next connect the flash drive to a USB socket in the scanner. A pop-up message „Update over USB?“ will appear on the screen. Press [Yes]. The update will start automatically. Wait until the system restarts.

11.3.2. Selecting a printer

If there is more than one printer driver installed in the device, the user will have to select the connected printer before printing. In order to do that enter [Settings], select /Info/ tab, find and select the connected printer in the „Set printer“ field.

You can set the scanner to ask for a printer selection before printing.

In order to do that select 'Choose printer during printing' in the "Set printer" field.

11.3.3. Remote access

Remote access allows the consultant to connect with the ultrasound machine for training and service purposes. The consultant may control camera settings and draw directions on the screen. The system does not provide an audio connection with the consultant - to do this, connect using a communicator suggested by the consultant.

11.3.3.1. Selection of remote access software

Depending on the preference of the consultant or support staff, AnyDesk or Splashtop software can be used for remote access.

To select one of them, press on the list expansion symbol next to the [Remote Access START] key. Select the appropriate option.

11.3.3.2. Setting up a remote access

To run remote access it is necessary to connect the ultrasound scanner to the Internet. To do so, connect a LAN cable or WiFi antenna to the device < 11.9.1. >.

To enable remote access, go to [Settings] and select the [Information] tab.

Press [Remote Access START].

A window with the customer number will appear on the screen. Provide consultant with this number. Wait for the consultant to take over the ultrasound scanner control. It should take several seconds.

Attention! Remember not to turn off the camera, router and Internet connection while the consultant is carrying out service work using remote access. This may result in system malfunction!

11.3.3.3. Disabling remote access

To disable remote access, go to [Settings] and select the [Information] tab.

Press [Remote Access STOP].

You can also disable remote access by interrupting the ultrasound machine's connection to the Internet.

11.3.4. Operating system protection

The operating system is protected from the unexpected changes of settings.

To make any changes in the operating system settings, you should turn off the protection before. It may be necessary, for example when installing a new printer.

To turn off the protection go to [Settings] and choose /Info/ tab. Unmark the "protect operating system" option. Restart the ultrasound scanner. Make a change to the system and turn on the protection. Restart the system again.

11.4. Date and time settings

Enter [Settings]. /Time/ tab is used to update the system date and time.

Enter the actual date and time. Next click [Save date and time] button.

11.5. Display

In the section /Display/ brightness and touch panel calibration options are available.

11.5.1. Display brightness

The brightness of the display can be adjusted from 10–100 units, in increments of 10.

The display brightness level is set to 50 at the factory.

11.5.2. Touch screen calibration

DRAMINSKI BLUE Vet Ultrasound scanner is calibrated.

In case of the system breakdown, it may be necessary to calibrate the touch panel again. It happens when the sensitivity and accuracy of the panel is lower.

To calibrate the touch panel go to [Settings] -> [Display]. Next tap [Touch panel calibration].

If you can not use the touch screen to enter the calibration mode, connect and use a mouse to do that.

11.5.3. Color temperature

Depending on your preference, you can change the color temperature of the display. Color neutral, Color cold and Color hot settings are available.

Color neutral strikes a balance between warm and cold volumes.

Color cold makes the image fall into cold tones (shades of blue).

Color hot makes the image fall into warm tones (shades of yellow).

11.6. Audio

You can adjust the volume of sound in the Audio tab.
To check the sound volume use the [Test sound] option.

11.6.1. Silent mode

Activating silent mode will mute all message sounds.
To activate silent mode, go to [Settings] and select the [Audio] tab.
Select the [Silent Mode] check box.
Uncheck the box to deactivate it.

Attention! In the silent mode, the system does not emit any acoustic signals, including information on the state of battery charge or its deep discharge.

11.7. Measurements settings

The measurements tab is used to modify the list of the measurements displayed in OB./GYN.
In order to activate the display of measurement tap the field next to its name.

11.8. DICOM settings

The DICOM settings window can be accessed in two ways:

1. Press [settings] → [DICOM] or
2. In the patient database, expand the list [Send DICOM] → [DICOM Settings].

11.8.1. Configuring the DICOM servers

Attention! Make sure the ultrasound scanner is properly connected to the facility's internal network or the Internet using a LAN cable or an external WiFi antenna (accessory).

To configure data export to the DICOM server, go to [Settings] and select the [DICOM] tab.
In the DICOM Record field, press [Add].
Fill in the fields according to the information from the server provider.
Specify whether the server should be treated as default using the [Default] check box.
Select the encoding method appropriate for the server from the [Encoding] list.
In the [Transfer syntax] list, specify the compression method for the server.
From the [Transfer syntax conversion] list, select the allowable server conversion option.
To check if the connection with the server is correct press [Echo]. The Echo OK message means that the ultrasound machine has connected to the server.
To finish the configuration press [Save]. The server will appear in the list in the DICOM Write field.

11.8.2. Editing DICOM server settings

To edit the DICOM server settings, go to [Settings] and select the [DICOM] tab.
In the DICOM Record field, select the desired server and press [Edit].
Complete the fields as desired and press [Save].

11.8.3. Data export in DICOM format onto an external USB device

To be able to export data to an external USB device in addition to the DICOM format, select the [Save USB in DICOM] check box on the [DICOM] tab in the [Settings] menu. From now on, the files will be exported to external memory in standard formats and additionally in a format compatible with the DICOM 3.0 standard.

11.9. WiFi

The ultrasound scanner can be connected to the Internet using an external Netgear A6100 WiFi antenna.

Attention! If you have an ultrasound scanner with firmware version 10460 or earlier, you must first update the software and then install the drivers.

11.9.1. Installation of WiFi antenna drivers

Attention! Driver installation is only required for customers with software version 10460 or older. The ultrasound software must be updated before installation. < 11.3.1. >



Do not connect the WiFi antenna to the ultrasound scanner before installing the drivers.

Disable edit lock in the operating system. < 11.3.4. >

Go to [Settings] and select the [WiFi] tab.

Press WiFi Connect – the system will display information about the lack of drivers or antenna,

after which the [Install A6100 Driver] button will appear below.

Press [Install A6100 Driver] and follow the instructions of the Installer.

After installing the driver, enable the edit lock in the operating system. < 11.3.4. >

Attention! If you want the ultrasound scanner to remember the network and connect to it automatically, configure the connection before enabling the edit lock in the operating system.

11.9.2. Internet connection via WiFi antenna

Attention! If you want the system to remember the network and connect to it automatically, disable operating system security before configuring the connection! < 11.3.4. >

Connect the Netgear A6100 antenna to the USB socket.

To establish a connection, press [Settings] and go to the [WiFi] tab.

Press Wi-Fi Connect. The system will display available WiFi networks. Select the network you want to connect to and press [Connect].

11.10. Loop

11.10.1. Maximum video loop length

To set the maximum number of frames for a video loop, go to [Settings] and select [Loop]

In the Maximum Cine Length field you can specify whether one video loop should contain a maximum of 128, 256 or 512 frames.

Remember that the duration of one video loop depends on the maximum number of frames and the number of frames per second (FPS) when recording the loop. This means that, e.g. a loop with the maximum frame length set to 256, with a refresh rate of 24 FPS it will last about 11 seconds. The FPS value is displayed in the information window during the test.

11.10.2. Choice of a style for creating file names exported to external storage

By default, the files are named according to the date of the examination, e.g. 20200112_14081415837, where 20200112 is the date and 14081415837 is the time.

File names can be generated in the following styles:

- <Date_Time> ,
- <Date_Time><Surname><Name> ,
- <Date_Time><Name><Surname> ,
- <Date_Time><Surname><Name><Description> ,
- <Date_time><Name><Surname><Description> .

To choose the style for creating names of exported files, go to Settings and select the Information tab.

In the “File name style” field, select the style name. The scanner saves the style settings automatically.

11.10.3. Selecting the extension of exported video loops

By default, video loops can be exported to external memory in the following formats: AVI, MOV, MP4.

To select the file type, go to [Settings] and select the [Information] tab. Expand the Format Cine list and select an extension. Close the settings.

To additionally export data in the DICOM format, see <11.8.3.> .

12. Charging and exploitation of the batteries

DRAMINIŃSKI battery pack is an efficient Li-Ion pack for multiple charging.

The lifetime of the battery pack depends on the way it is used. The best practice is it works full cycles, i.e. full charging – full discharging.

12.1. Checking the battery charge status before turning on the scanner

To check the battery charge status when the device is turned off, press the power button briefly. If the battery is charged, the device will emit 1 to 4 acoustic signals*:

1 signal= 25% charged battery

2 signal= 50% charged battery

3 signal= 75% charged battery

4 signal= 100% charged battery

* No signal means the battery is deeply discharged or this function has been disabled after activating the silent mode in the Audio tab of the Settings menu.

12.2. Checking the battery charge status during operation

In the upper right corner of the screen there is a graphic indicator of the battery charge status.

A fully charged packet (green indicator) powers the ultrasound scanner for an average of 2 hours 30 minutes.

Change of the color of the indicator from green to yellow indicates that the battery will work for about 45 minutes.

Change of the color from yellow to red indicates that the battery will last for about 10 minutes.

The message “Low battery” in the center of the screen means the battery must be charged. If you leave the scanner turned on, after a short time it will emit a long beep and it will automatically turn off to protect against system damage.

12.3. Charging DRAMINIŃSKI battery pack

Attention! To charge the battery use a dedicated AC adaptor with specially selected current parameters. It is advised to use only the XP Power AHM 100PS19 model.

To charge the battery plug the ultrasound scanner to the mains using AHM 100PS19 AC adaptor. The blue diode around ON/OFF button is flashing during charging process.

Charging the full discharged battery takes 4 hours. Internal charger stops working automatically after the battery is fully charged.

The lifetime of the battery is about 500 charging cycles. When the working time is too short it means that the battery shows a high degree of wear and should be replaced with a new one.

13. Maintenance of the device

When the device is used it becomes dirty, including different infective factors. Directly after work, the device should be cleaned with a damp, wet cloth or paper towel, using a mild detergent. When cleaning, protect slots in the casing from moisture.

The surface of the device should be disinfected with a special agent for used for disinfecting medical equipment. It is recommended to use foam or spray agents or tissues moisturized with disinfecting agent.

Attention! Ultrasonic probes must be carefully disinfected after each use.

After cleaning with a damp cloth, the ultrasound scanner should be wiped dry with a paper towel, if necessary.

While cleaning the personnel performing these tasks should wear protective clothing.

The touch panel requires regular cleaning. For this purpose use relevant agents (foams, aerosols, cleaning tissues for touch screens) which guarantee thorough cleaning and at the same time protect the surface of the panel against mechanical damage.

The carrying case should be cleaned externally with water and detergent. The foam insert should be vacuumed regularly and cleaned with water and a mild detergent. A disinfectant solution, e.g. Virkon S, may be used for disinfection. Before using the carrying case, make sure that the foam insert is completely dry.



Warning! – It is forbidden to use highly concentrated, aggressive agents and abrasives. These agents can damage the surface of the panel or the casing. When cleaning, protect all the slots, sockets and holes in the casing from moisture.

The life expectancy of the device is about 10 years, but it can be prolonged if periodical maintenance inspections are followed.











It is recommended the user of the ultrasound scanner perform regular technical inspections every two years at the manufacturer's facility.

14. Troubleshooting

Symptoms	Action
The device will not turn on	<ol style="list-style-type: none"> 1. Press and hold the power buttons. 2. Check if the power supply cable is properly connected. 3. When on battery supply – it may be a symptom of a full discharge of the battery.
The device switches on but the operation system will not start	<ol style="list-style-type: none"> 1. Check if an external medium is connected to the USB port. If yes, disconnect it and then turn off and turn on the device again.
Improper image or lack of image	<ol style="list-style-type: none"> 1. Check that the probe is properly connected – disconnect and connect the probe again. 2. Check if the probe is locked properly 3. Check if the symbol displayed in the information bar corresponds to the symbol of the connected probe. 4. Check if the slots in connector and probe port are dirty. If yes, use a compressed air to remove the dirt.
Image is too dark or too bright	<ol style="list-style-type: none"> 1. Check if gain and gamma levels are set correctly.
There are fringes in the image	<p>Probably there are interferences from the power supply network.</p> <ol style="list-style-type: none"> 1. Use the battery power supply 2. Plug in the AC adaptor to another mains socket.
No charging signal	<ol style="list-style-type: none"> 1. Check connections of all cables and their condition. 2. Check power supply 110–240 V / 60Hz
Short battery operating time	<ol style="list-style-type: none"> 1. Battery is not fully charged 2. Low ambient temperature 3. Battery is worn (a normal symptom resulting from the battery's construction and rules of using the battery)
Message on the screen "Probe OFF" unabling examination	<ol style="list-style-type: none"> 1. Check if the ultrasound head is properly connected. Disconnect and connect the head again. Make sure that the probe is properly connected (the "Probe ON" message will appear which will automatically disappear and enable performing the examination).
Messages on the screen unabling performing examination	<ol style="list-style-type: none"> 1. Turn off and turn on the device again. If the symptoms continue contact the producer or authorized service centre.
Mechanical damage of the casing, its elements of cables.	<ol style="list-style-type: none"> 1. Examine the device and after having contacted the authorized service centre or the producer follow their recommendations.

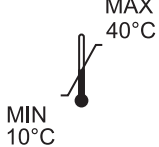
If any of the basic activities do not help or other problems appear contact DRAMINSKI service, call **+48 89 675 26 00** or e-mail: **sales@draminski.com**

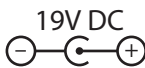
15. Symbols and marks used on the labels

	<p>The CE mark means that the product complies with the valid EU Directives.</p>
	<p>Attention, familiarize yourself with the user manual</p>
	<p>Warnings regarding user safety</p>
	<p>Date of production</p>
	<p>Manufacturer's name and address</p>
	<p>Dispose of separately from other domestic wastes in accordance with Directive of the EU Committee UE 93/86/EEC or local regulations.</p>
<p>IP30</p>	<p>Level of casing resistance to external factors – penetration of solid bodies and dust, level of water resistance.</p>
<p>SN-</p>	<p>Serial number</p>
	<p>Storage temperature</p>
	<p>Careful, fragile</p>
	<p>BF type for parts applied directly to the patient's body. B – body, F – Floating applied part.</p>
<p>IP30</p>	<p>International protection rating</p>
	<p>Information about voltage and polarity of the AC Adaptor</p>
	<p>Information about the correct direction of the connector fitting in the probe port</p>

16. Warranty

The manufacturer hereby grants the buyer a 24-month warranty for a trouble-free operation of the product (body of scanner and probe) if it is used in accordance with the attached user manual.

The battery for the device has a 6-month warranty.

In case of any failure occurring at no fault of the user, the manufacturer undertakes to repair the product not later than within working 14 days from the date of receiving the device at the service centre (Wiktora Steffena 21, 11-036 Sząbruk, Poland) and to return the device in good working order at the manufacturer's cost.

The warranty excludes mechanical damage, damage resulting from improper operation, storage and independent repairs.

The warranty is processed based on a proof of purchase (invoice). To make a complaint, the user should inform the Dramiński Company immediately of any suspected fault.

To make a complaint on account of warranty the user should be able present:

1. Notify DRAMIŃSKI S.A. of the device malfunction immediately after it occurs.
2. Send the device to the Service Department (no later than before the warranty expiration date) or deliver it in person together with the proof of purchase, which should include the seller's and purchaser's details, the date and place of purchase, the device name, and its serial number.
3. A description of the malfunction must be enclosed with the device sent to the Service Department to ensure efficient diagnosis and repair of the damage:
 - Before shipping, the ultrasound device, carrying case, and all included accessories must be cleaned and disinfected (*in accordance with the Cleaning and Disinfection section),
 - Please pay particular attention when packaging the device to ensure that it is properly secured, as the manufacturer shall not be held liable for any damage incurred during transport.

The warrant is:

DRAMIŃSKI S.A.
Wiktora Steffena 21,
11-036 Sząbruk
Poland

Phone + 48 89 675 26 00
E-mail: sales@draminski.com
www.draminski.com



DRAMIŃSKI S.A.

Wiktora Steffena 21, 11-036 Sząbruk, Poland

Phone: +48 89 675 26 00

E-mail: sales@draminski.com

www.draminski.com
