

iScan 2

Veterinary Ultrasound Scanner



USER MANUAL

Manufactured by:

DRAMINSKI S.A.

Wiktora Steffena 21
11-036 Sząbruk
Poland

Phone: +48 89 675 26 00
e-mail: sales@draminski.com
www.draminski.com

Dramiński S.A. has established and maintained a full quality control system in accordance with the requirements of **EN ISO 9001**. The system is periodically audited by TUV Rheinland LGA Products GmbH notified body, Tillystrasse 2, 90431, Nurnberg, Germany which participates in the conformity assessment process.

Declaration of conformity

It can be obtained in our Sales Department:

Phone: +48 89 675 26 00
e-mail: sales@draminski.com

We wish you and users of this product a lot of success when taking care of your patients. We are sure that with our product you will be able to serve your patients well.

All comments and suggestions of your customers concerning the device and this user manual, DRAMINSKI company will accept with a lot of interest.

Please, call us at + **48 89 675 26 00**
or write an e-mail: sales@draminski.com

Developed by DRAMINSKI S.A.

All rights reserved.

Copying without DRAMINSKI S.A. approval is forbidden.

Introduction

1. Introduction	5
1.1. Information about the user guide of the device	5
1.2. Warnings, comments and symbols used in the user guide	5
1.3. Brief information about ultrasonography	5
1.4. Preliminary information about iScan 2 – a portable ultrasound scanner	5
2. Safety of use	6
3. List of elements of the DRAMIŃSKI iScan 2 ultrasound scanner	7
4. Construction of the iScan 2	8
4.1. Casing	8
4.2. Probe	9
4.3. Battery	10
4.4. Charger	11
5. How to prepare for operating	12
5.1. Data transmission slot protecting plug	12
5.2. How to charge the batteries	12
5.3. How to connect the batteries to the ultrasound scanner	13
5.4. How to adjust the carrying belt	13
5.5. How to turn the ultrasound scanner on	13
6. How to end operation of the ultrasound scanner	14
6.1. How to turn the ultrasound scanner off	14
6.2. Washing and disinfection	14
7. User panel	15
8. Menu structure of the ultrasound scanner	16
8.1. Quick access menu customization	18
9. Description of the ultrasound scanner's functions	19
9.1. Setting the parameters of imaging	19
9.1.1. Gain adjustment	19
9.1.2. Adjustment of depth of scanning	19
9.1.3. Focusing	19
9.1.4. Frequency	19
9.1.5. Gamma	20
9.1.6. Frame averaging	20
9.1.7. Zoom	20
9.1.8. Postprocessing	20
9.1.9. Negative	21
9.2. Presets	21
9.3. How to create presets	21
9.4. How to upload presets	21
9.5. Freeze	22
9.5.1. How to freeze the image	22
9.5.2. Follicle	22
9.6. Cine loop	23
9.7. Measurements	23
9.7.1. Distance	23
9.7.2. Surface area	23
9.7.3. Volume	24
9.7.4. Measurement of adipose tissue thickness	24
9.7.5. Biometry of embryos	24
9.7.5.1. Cow CRL – embryo length	25
9.7.5.2. Cow BPD – head diameter measured between the fontanelles	25
9.7.5.3. Horse VD – germinal vesicle size	25
9.7.5.4. Horse HD – head diameter	25

9.7.5.5. Horse OD – eye diameter	25
9.7.5.6. Sheep CRL – embryo length	25
9.7.5.7. Lama BPD – head diameter measured between the fontanelles	26
9.7.5.8. Pig CRL – embryo length	26
9.7.6. Grid	26
9.8. Full screen	26
9.9. Rotate the image	26
9.10. How to save data	27
9.10.1. Save image	27
9.10.2. Save cine loop	27
9.11. How to upload the data on the screen	28
9.11.1. Upload image	28
9.11.2. Upload cine loop	28
9.11.3. Search images and cine loops	28
9.12. How to export data to the external data storage device	28
9.13. How to delete data from the internal memory	28
10. Modes of imaging	30
10.1. B+B Mode	30
10.2. B+M Mode	30
11. System settings	31
11.1. Change left / right	31
11.2. Date/Time	31
11.3. Brightness	31
11.4. Language	31
11.5. Default settings	31
11.6. Automatic turn off	31
12. Accessories	32
12.1. Goggle	32
12.2. Sunshield	33
12.3. Extension for the linear rectal probe	33
12.4. WiFi antenna	34
12.4.1. Connecting the phone to the ultrasound scanner:	34
12.4.2. Turning off WiFi	34
13. Maintenance of the device and the probes	35
13.1. Washing and disinfection	35
13.2. Technical checks	35
14. Transportation of the device	36
15. Exploitation and technical notes	37
15.1. Trouble shooting	37
16. Technical data	38
17. Software information	40
18. Demo	40
19. Warranty	41

1. Introduction

1.1. Information about the user guide of the device

Particular parts of the user guide describe construction, accessories of the device, how to prepare it to operation, functions and operation of the ultrasound scanner. Before starting to use the ultrasound scanner, please familiarize yourself with the user guide.



Reading the content of the user guide does not substitute even basic ultrasonography course. The user is recommended to undergo an authorized ultrasound course.

1.2. Warnings, comments and symbols used in the user guide

Regarding the necessity to underline important content, the following means of distinguishing are used:



Warning! – when it is necessary to pay special attention regarding patient or user safety.

Attention! – when it is necessary to draw attention at protection of the device or its proper use.

Bold text – when it is necessary to draw attention to important fragments in the user guide or to make this information more clear and legible.

Descriptions of schemes and pictures – in order to make details more visible.

Symbols used in the user guide do not inform about all safety instructions, that is why it is necessary to read the instructions (Part 2) first and follow them!

Symbols used in the text:

<x.x.x> – reference to a part of the user guide x.x.x

(option) – availability of functions depends on the version of the device or its equipment

1.3. Brief information about ultrasonography

Ultrasounds find a wide variety of use in veterinary medicine, including medical imaging. Tissues reflect and absorb ultrasounds differently. The ultrasound scanner presents the two dimensional image in 256 shades of grey. White elements come from the tissue which strongly reflect the waves. However, black elements come from the areas which do not reflect ultrasound waves. This method is widely used in diagnostic of the abdominal cavity, reproductive system, muscular–skeleton system, lungs and other systems.

Diagnostic efficiency of ultrasonography is very high. However, a lot of influence on the efficiency of this method has: the quality of devices, individual experience, knowledge of a user and following the standards of ultrasound tests as well as familiarizing yourself with the user guide.

1.4. Preliminary information about iScan 2 – a portable ultrasound scanner

The iScan 2 ultrasound scanner is designed to test reproductive system of horses, cattle and small ruminants. There are two versions of the scanner: with a rectal convex probe and with a rectal linear probe. The type of the probe should be determined by the user when purchasing the scanner (it is possible to use other types of probes, however, this should be consulted with the deliverer).

The iScan 2 has a 7" monitor and it weighs 2.4 kg. The system has a function of postprocessing which improves the quality of the image. The quick access menu can be adjusted to your own needs, which accelerates operation of the device.

The iScan 2 is characterized by a high class of dust and water resistance. However, it is necessary to remember that before cleaning the battery should be detached from the device. The battery capacity allows to work 6 hours on a single charge.

2. Safety of use



Warning!

User safety and patient safety depend on following the following instructions!

1. The DRAMIŃSKI iScan 2 is a device which should be used in diagnostic purposes only by qualified personnel.
2. The ultrasound scanner and its equipment should be disinfected as it might be in contact with contagious substances.
3. It is recommended not to use the ultrasound scanner simultaneously with other high frequency devices (HF).
4. The users of the ultrasound scanner are recommended to perform regular technical checks at the manufacturer, every two years. It will guarantee fault-free operation of the device.
5. It is forbidden to dismantle the device and carry out autonomous repairs and adjustments, except the activities described in the user guide.
6. The users of the ultrasound scanner are recommended to check the probe cable and places where it is connected to the ultrasound scanner regularly in order to find possible mechanical damage.
7. In case of notice of mechanical damage of the probe or the cable, it is required to send the device to the service.
8. The ultrasound scanner has a solid construction, however, in order to avoid mechanical damage, please, follow the instructions mentioned in this part of the user guide.
9. Exposure of the device to strong sunlight should be avoided. It is better to observe the temperature recommended on the stickers of the device and its elements.
10. It is forbidden to introduce any modifications to the device by the user.
11. The DRAMIŃSKI iScan 2 is an electric device which can be a source of electromagnetic radiation. Its operation can be disturbed by other electric devices, that is why it is recommended to limit the number of electric devices working simultaneously nearby.
12. After the period of usage, taking into account the risk for the environment, the device and the accessories should be recycled by specially qualified bodies in accordance with the current law or sent back to the manufacturer.

3. List of elements of the DRAMIŃSKI iScan 2 ultrasound scanner

All additional accessories which can be used with the iScan 2 ultrasound scanner are available after consulting the deliverer.

	Name and description	Quantity
Standard equipment		
1	Ultrasound scanner with a permanently fixed probe	1
2	External battery	1
3	Battery charger with a charging cable 230V	1
4	Adapter to connect USB memory	1
5	Carrying belt and waist belt	1
6	Transport case	1
7	User guide	1
8	Ultrasound gel 250ml	1
Additional equipment		
9	Goggle	option
10	Sunshield	option
11	Extension to linear rectal probe	option

4. Construction of the iScan 2

The device consists of: a casing, a probe permanently fixed to the casing, a battery and a charger. There are two slots on the casing to connect goggle and USB memory adapter.

Attention!

The ultrasound scanner has a solid construction. However, during operating and transportation it is necessary to be careful in order not to subject the device to strong impacts and not to damage it. The slots should be protected against dirt and moisture.

4.1. Casing

The view and description of the elements of the casing:



Casing. Front view.

- 1 Hooks for carrying belts
- 2 Screen
- 3 Probe cable
- 4 Keyboard
- 5 Goggle slot (upper)
- 6 Data transmission slot (lower)



Keyboard

- 1 Freeze
- 2 Back
- 3 Confirm / Menu
- 4 Navigation buttons
- 5 Gain general
- 6 Gain in the further area
- 7 ON / OFF / Freeze

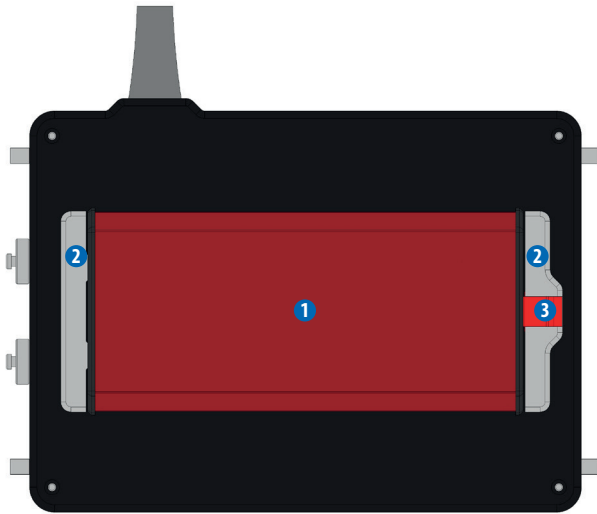

Casing. Rear view.

- 1 Battery
- 2 System of battery attachment
- 3 Lock

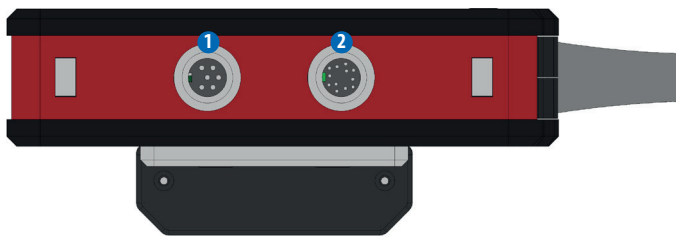

Casing. Right side view.

- 1 Data transmission slot
- 2 Google slot

4.2. Probe

The probe is permanently fixed to the ultrasound scanner.

iScan 2 is available in two versions: with a linear rectal probe and a convex rectal probe.



Linear rectal probe 7.0 MHz

- Range of frequency from 4 to 9MHz
- Active area = 60mm
- Ultrasound range up to 15 cm
- Consists of 128 elements

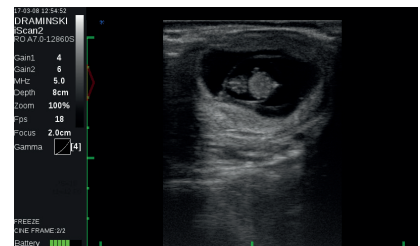

Exemplary picture



Convex rectal probe 5.0 MHz

Range from 3 to 7,5 MHz
 Radius = 61,2 cm
 Scanning angle = 64°
 Ultrasound range up to 25 cm
 Consists of 128 elements

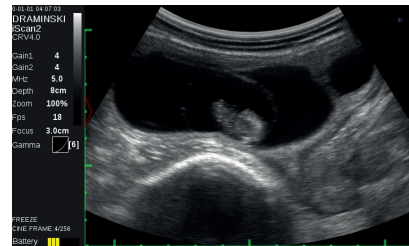

Exemplary picture

4.3. Battery



Warning!

The battery must be charged with the battery charger supplied by the manufacturer.

The ultrasound scanner is powered by a Li-Ion battery designed for multiple recharging. The battery has an internal thermal fuse protecting it against overheating when it is being charged.

There is a socket in the battery casing to connect the cable of the charger and special contacts to be connected to the ultrasound scanner.

The battery is attached at the bottom of the ultrasound scanner. <4.1>



Akumulator

1 Contacts for ultrasound connection
 2 Charger cable socket

Safety measures in handling a Li-Ion battery pack:

- It is forbidden to dismantle the battery pack which is an integrated whole.
- Do not clench the contacts on the battery pack casing with metal things.
- Do not throw battery packs into the fire nor heat them.
- It is forbidden to impact on the battery packs mechanically, do not throw them.
- In the case when a leakage of the electrolyte is observed, stop using the battery pack immediately.
- Prevent the battery pack from penetration of liquid inside of it, it may cause a sudden temperature rise and danger.

- Battery packs should not be left in high temperature of the environment, for example, inside a car directly in the sunlight, or near a source of heat. Failure to follow these principles can cause leakage of the electrolyte from the battery and its damage or shorten its service life.
- The battery should be charge in the temperature between 0° C and 40° C. Charging the battery in other temperature range can cause danger and permanent harm to the battery pack.
- In the case of occurrence of problems with charging after a long service period (about 500 cycles), it is necessary to replace the old battery pack with a new one.
- The disposed battery pack should be recycled in accordance with the current law.

4.4. Charger

Mascot charger, type 2440, is designed to charge the iScan 2 ultrasound scanner only. It is adapted to the mains 110–240V/60Hz.

A colourful diode shows the level of battery charging. The red colour means that the battery is discharged, the green colour means that the battery is charged.



Battery charger



Warning! It is forbidden to perform any unauthorized repair of the charger nor dismantle the device.

Regarding the user safety and durability of the device, the charger should not be used in humid and wet places.

Before you start using the charger, always check if its main elements, including the cables, are not damaged.

Attention! In the case of finding any damage, it is necessary to disconnect the device from the source of power supply immediately and exchange the damaged part by a new one via contacting with an authorized service.

5. How to prepare for operating

5.1. Data transmission slot protecting plug

During operation, the data transmission slot protecting plug must be untightened. Remember to tighten the plug before cleaning the device, and then untighten it when the housing is dry.

The goggle slot protecting plug should be tightened whenever the goggles are not connected to the device.

The data transmission slot features a valve to compensate for the atmospheric pressure in the device. When switched on, the device heats up and the air contained in it expands. Excessive pressure inside the device can damage the seal. To avoid this, untighten the data transmission slot protection plug by two turns after switching on the device. Do not untighten the plug completely to prevent damp air from entering the housing.

Remember to tighten the plug before cleaning the device, and then untighten it when the housing is dry.

Tighten the plug when storing the device in an environment with high air humidity. It can also be tightened during operation when the values of the external pressure and the pressure in the device are equal.



Data transmission slot protecting plug

5.2. How to charge the batteries

iScan 2 is powered by Li-Ion battery 14.4V 6.8Ah.

Charging time: 4 hours.

Operating time: up to 7 hours when fully charged.

In order to charge the battery:

1. Turn off the ultrasound scanner.
2. Disconnect the battery from the ultrasound scanner.
3. Connect the charger cable to the socket in the battery.
4. Connect the charger to the mains.
5. When the diode changes its colour from red, via orange, yellow into green – your battery is properly and fully charged.
6. Disconnect the battery from the charger.
7. Disconnect the charger from the mains.

When the green diode of the charger starts flashing, it means that the battery is charged and the charger is in stand-by mode.

5.3. How to connect the batteries to the ultrasound scanner

The battery is to be connected on the rear wall of the ultrasound scanner.

Before connecting, make sure that the contacts of the ultrasound scanner and the battery are dry.

In order to connect the battery, follow this pictogram:

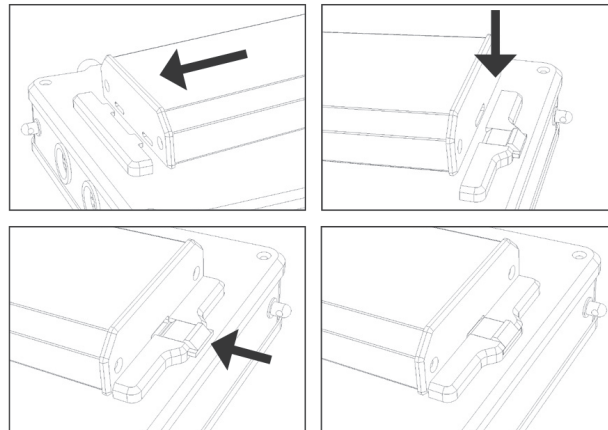

How to connect the batteries

5.4. How to adjust the carrying belt

In order to adjust the height and the angle of the ultrasound scanner on the carrying belt, follow the pictograms below:

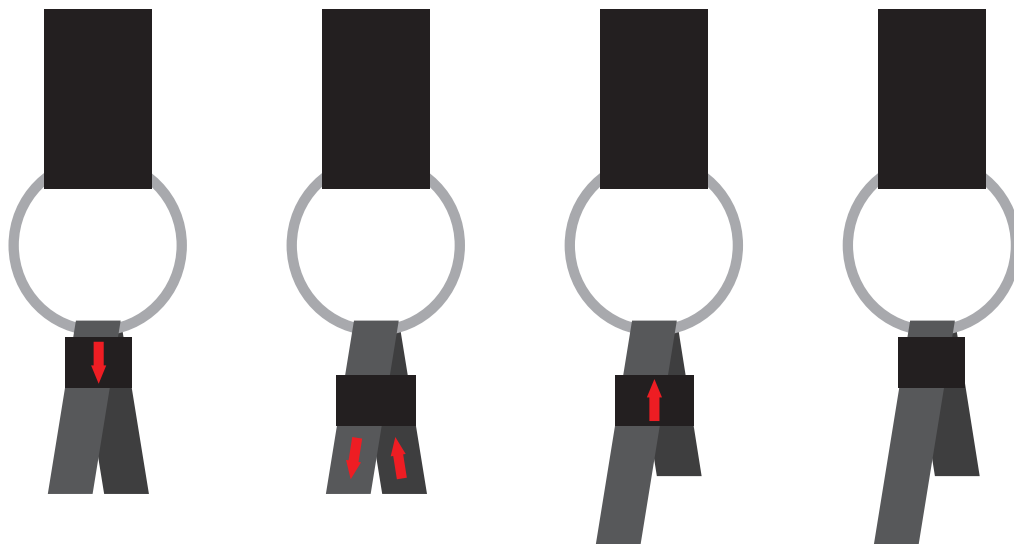

How to adjust the carrying belt

5.5. How to turn the ultrasound scanner on

In order to turn on the ultrasound scanner:

1. Attach the battery.
2. Press the On / Off button and wait for about 20 seconds.
3. When the image from the probe appears on the screen, the scanner is ready for operation.

6. How to end operation of the ultrasound scanner

6.1. How to turn the ultrasound scanner off

In order to turn the ultrasound scanner off, hold the On / Off button for about 2 seconds.

Remember, briefly pressing of this buttons makes the image freeze.

6.2. Washing and disinfection

Remember to wash and disinfect the ultrasound scanner after finishing work with it. Tighten the plug before cleaning the device, and then untighten it when the housing is dry.

Attention! Do not wash the ultrasound scanner in pressurized water!

Attention! Remember not to make the battery contacts wet!

In order to wash the ultrasound scanner:

1. Turn off the power supply.
2. Disconnect the battery.
3. Put the protecting plugs into the goggle and data transmission sockets.
4. Wash the probe and the ultrasound scanner in running water.
5. Wipe the ultrasound scanner dry, for example, with a paper towel.
6. Clean the battery with a wet paper towel, and wipe it dry.

To disinfect the ultrasound scanner and its accessories, use the agents designed for disinfection of medical devices which do not contain alcohol.

7. User panel

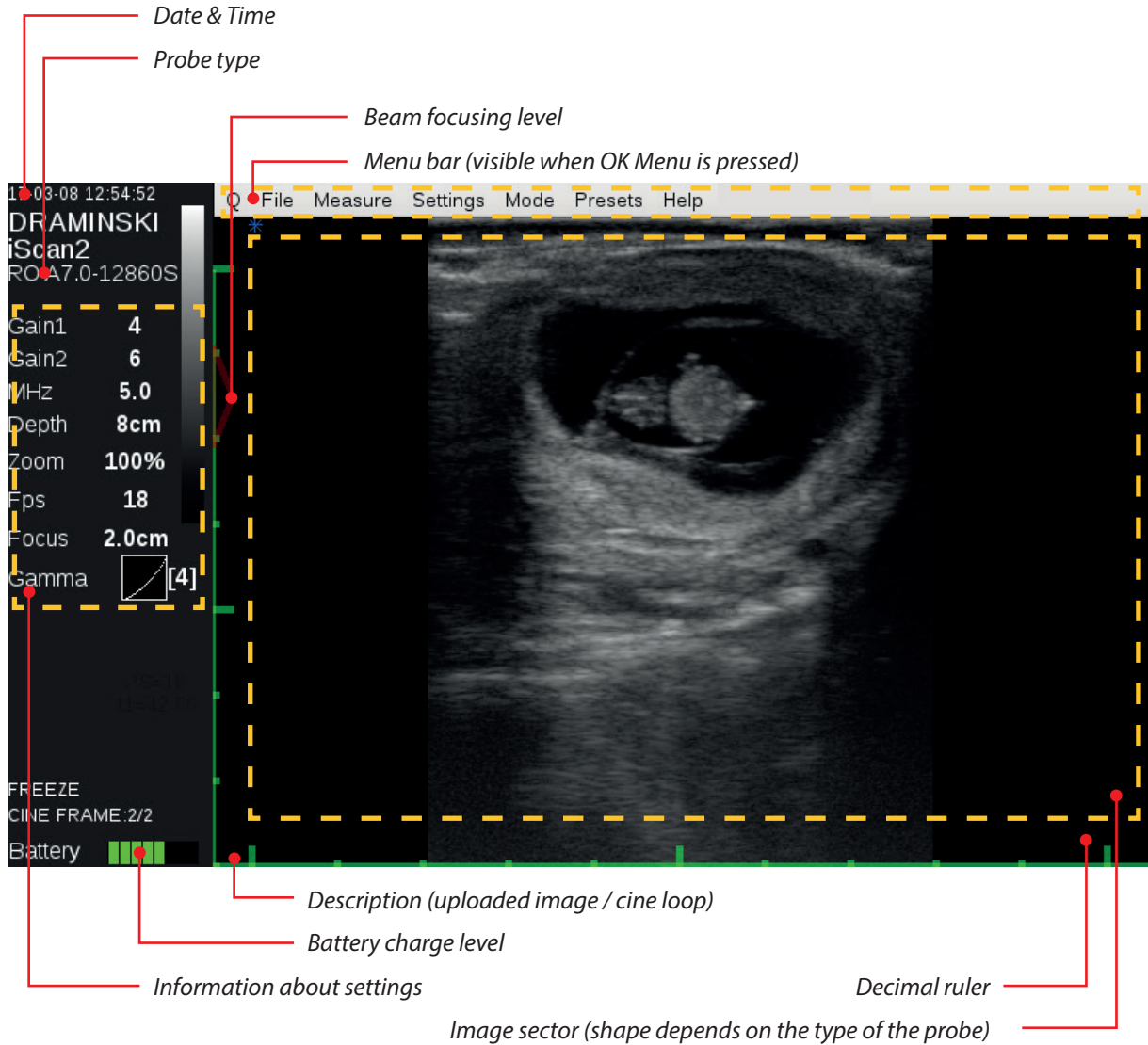

User panel

8. Menu structure of the ultrasound scanner

In order to open the Menu, press OK. Menu.

In order to escape the Menu, press ESC.

When you choose some functions, there appears a tip on the screen which explains how to change their settings.

The following pictograms show the whole structure of the Menu:

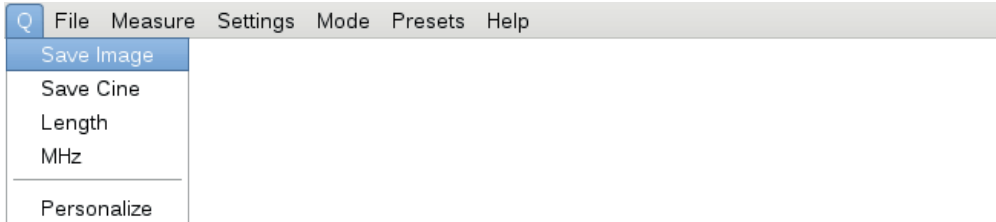

Customized Quick Access Menu

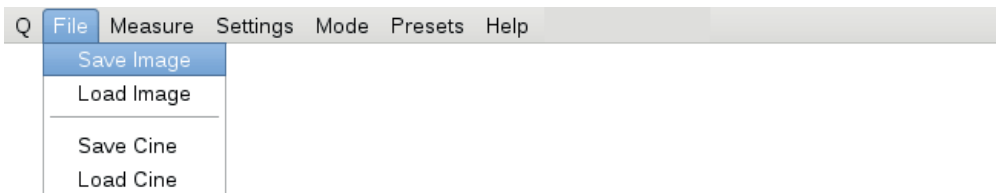

Menu used to save and upload images and cine loops on the screen

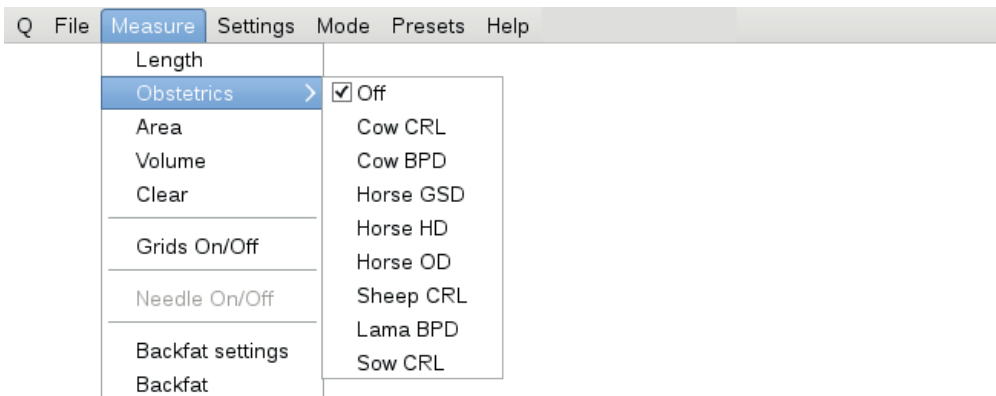

Measuring menu

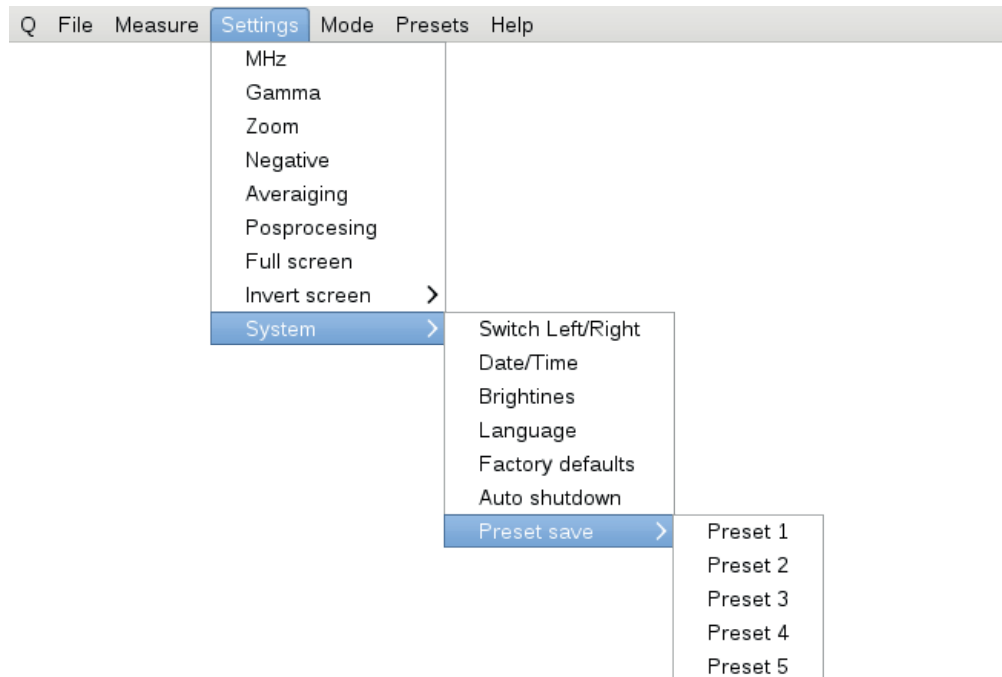

Settings menu

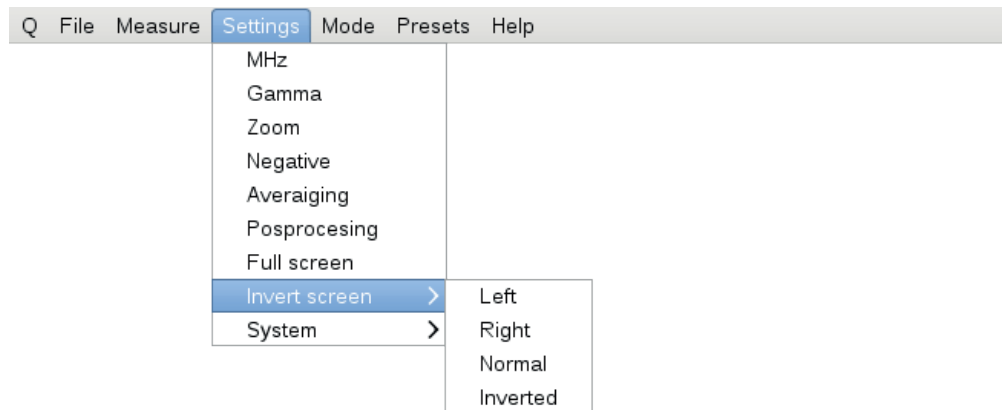

Screen rotation menu

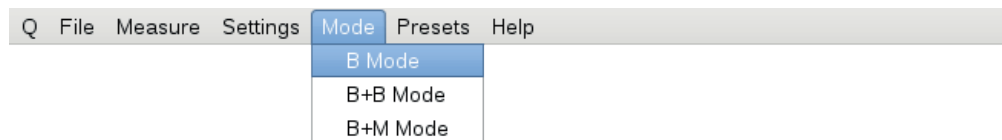

Imaging mode menu

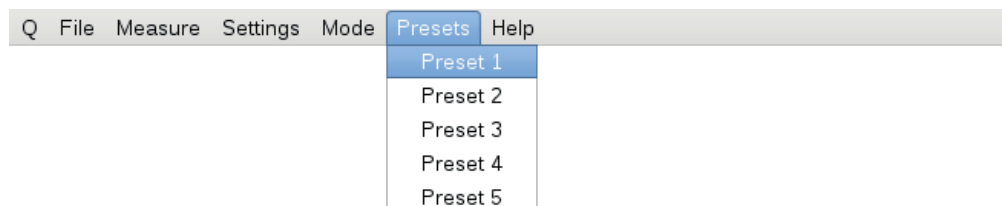

Presets. Menu of customized user defined presets.

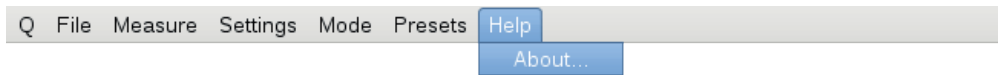

Help menu

8.1. Quick access menu customization

The ultrasound scanner has a Quick access menu function which enables selection of functions among those available in the standard menu and locating them in one bookmark in the selected order.

It is marked with the letter „Q” in the system (Quick).

In order to customize Quick access menu:

1. Click the OK Menu button.
2. In the bookmark „Q” choose Customize.
3. With the help of UP / DOWN arrows find the element which you would like to be show in Q Menu.
4. Select the element using RIGHT / LEFT arrows.
5. Repeat the same procedure for the other elements.
6. The selected element can be moved on the list by clicking G1 and simultaneous clicking on UP / DOWN arrows.
7. In order to confirm settings of Q Menu, press the OK Menu button.

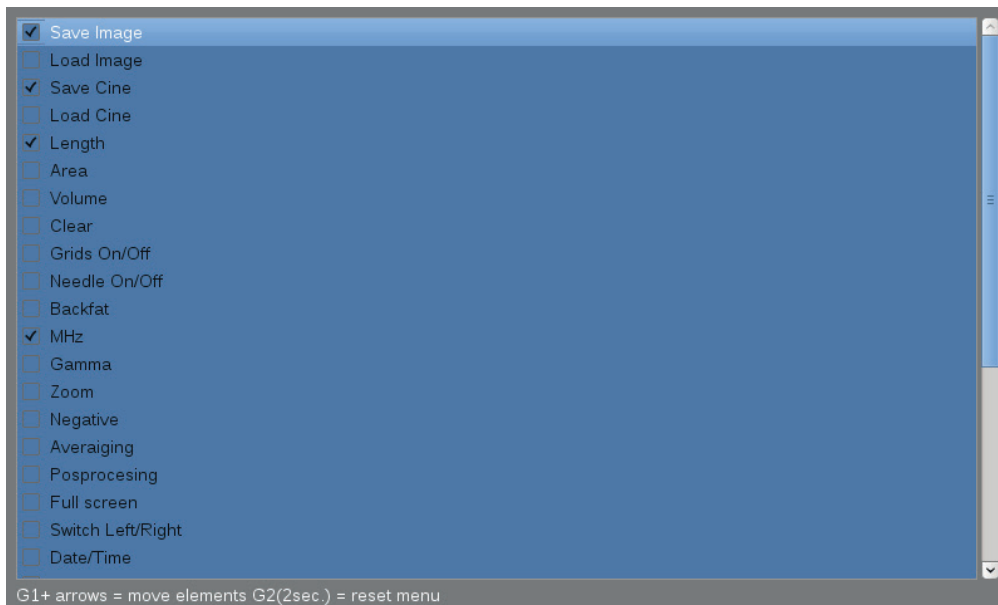

List of options to be shown in Quick Access Menu

Attention! To correctly save Quick Access Menu settings ultrasound scanner should be in workin mode – image unfreezed.

When the ultrasound scanner is turned off, it remembers the Q Menu settings.

In order to reset the settings, choose the option Customize and hold the G2 button for about 2 seconds.

9. Description of the ultrasound scanner's functions

9.1. Setting the parameters of imaging

9.1.1. Gain adjustment

The signal gain can be adjusted completely or in a background area of the image. It causes that the structures, which are presented on the screen, become lighter or darker.

In order to adjust gain completely:

1. Press G1.
2. Use the UP / DOWN arrows in order to set the level of gain.
3. Confirm with the OK button or wait until the tip disappears.

In order to adjust gain in the background area:

1. Press G2.
2. Use the UP / DOWN arrows in order to set the level of gain.
3. Confirm with the OK button or wait until the tip disappears.

9.1.2. Adjustment of depth of scanning

In order to adjust the depth of scanning, use the LEFT / RIGHT arrows, where LEFT means scanning of shallowly located organs, and RIGHT means scanning of deeply located organs.

Maximal depth of scanning depends on the probe and it is:

- for linear rectal probe – 15 cm,
- for linear convex probe – 25 cm.

9.1.3. Focusing

The ultrasound scanner can change the level on which the ultrasound beam is focused the most. In the area where the beam focuses the most, the signal is the strongest and the image resolution is the highest.

In order to set the beam focusing on the area which you are interested in, use the UP / DOWN arrows, where UP causes that the beam focuses the shallowest, and DOWN – the deepest.

9.1.4. Frequency

The probes available with the iScan 2 ultrasound scanner are broadband, high frequency probes. It means that the user can decide in which range of frequency their probe is to be operated.

It is necessary to remember about the following principle:

1. Higher frequency = better resolution = less efficient depth of scanning.
2. Lower frequency = worse resolution = more efficient depth of scanning.

In order to change frequency:

1. Press OK Menu.
2. Go to Settings.
3. Select MHz.
4. Use the UP / DOWN buttons to choose the most efficient frequency.
5. Press OK Menu.

9.1.5. Gamma

Adjustment of gamma changes the way the grey scale is shown on the screen.

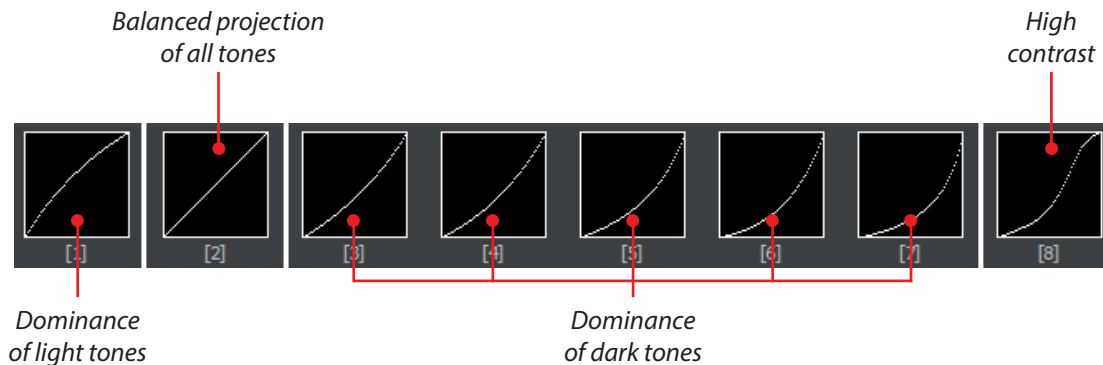

In order to change Gamma settings:

1. Press OK Menu.
2. Go to Settings.
3. Select Gamma.
4. Using the arrows select a proper setting.
5. Confirm with the OK button.

9.1.6. Frame averaging

This function enables anti-aliasing by imposing every second neighbouring frame and projecting them simultaneously.

In order to change averaging of frames:

1. Press OK Menu.
2. Go to Settings.
3. Select Frame averaging.
4. Use arrows to select proper settings.
5. Confirm with the OK button.

9.1.7. Zoom

Zooming can be adjusted at 20% increments, in the range:

- -60% – 100% (reducing the image),
- 100% – 200% (magnifying the image).

In order to change Zoom:

1. Press OK Menu.
2. Go to Settings.
3. Select Zoom.
4. Use arrows to select proper settings.
5. Confirm with the OK button.

9.1.8. Postprocessing

Postprocessing is a tool which causes: smoother anti-aliased edges, enhancement of pulp structures, improvement of contrast.

In order to On / Off Postprocessing:

1. Press OK Menu.
2. Go to Settings.
3. Select Postprocessing.
4. Use arrows to select proper settings.
5. Confirm with the OK button.

9.1.9. Negative

This function enables viewing the image in negative.

In order to On / Off Negative:

1. Press OK Menu.
2. Go to Settings.
3. Select Negative.
4. Use arrows to select proper settings.
5. Confirm with the OK button.

9.2. Presets

This option enables saving your favourite parameters of imaging with a selected name.

The system can save up to 5 presets.

9.3. How to create presets

In order to create a preset:

1. Optimize testing parameters: G1, G2, frequency, depth of scanning, focusing, zooming and gamma.
2. Press OK Menu.
3. Go to Settings.
4. Go to System.
5. Go to Save preset.
6. Select Preset 1.
7. A dialog box will appear with a question: Save the settings to a preset? YES/NO.
8. Confirm with the OK button.
9. Enter the preset name using the navigating buttons.
10. Confirm with the OK button.

9.4. How to upload presets

In order to upload the settings saved in the preset:

1. Press OK Menu.
2. Go to Presets.
3. Select a proper preset.
4. Confirm with the OK button.

9.5. Freeze

9.5.1. How to freeze the image

In order to freeze the image, press Freeze or ON/OFF.

At the bottom of the information box a message FREEZE appears. Pressing one of the buttons again defreezes the image.

9.5.2. Follicle

Automatic follicle measurement allows you to quickly determine the largest dimension of a follicle.

For a correct measurement as clear image of the follicle as possible has to be obtained.

In order to measure a follicle:

1. Freeze the image.
2. Open the Menu and move to the Measure tab.
3. Select Follicle.
4. Place the measurement cursor in the center of the follicle.
5. Confirm the position of the cursor with OK. The system traces the boundaries of the follicle.
6. If the outline does not match the follicle boundary, use the up / down arrows to change the measurement sensitivity (Thr) or the left / right arrows to change the degree of roundness of the measurement (Ten).
7. The result is presented in mm.

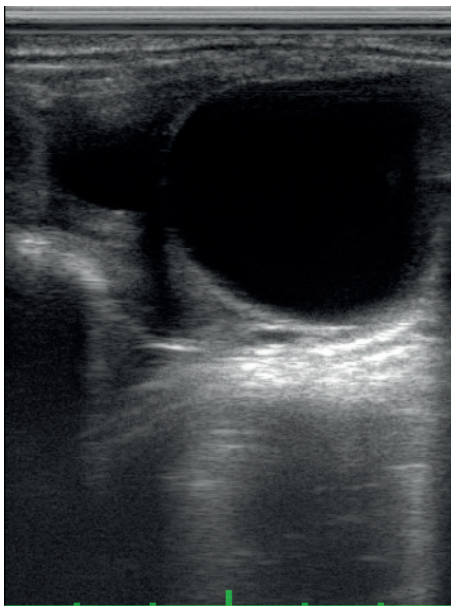

Follicle before measurement

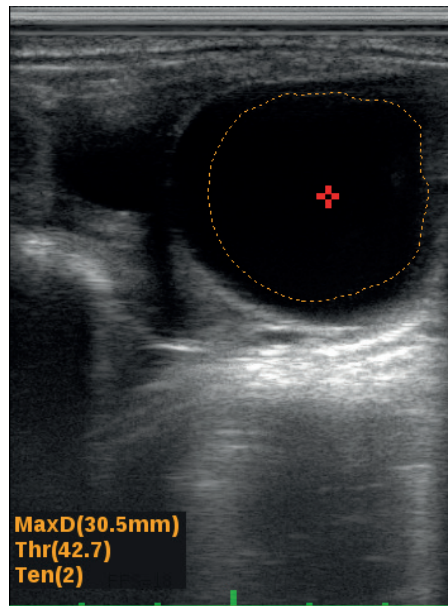

Follicle measurement – sensitivity too low

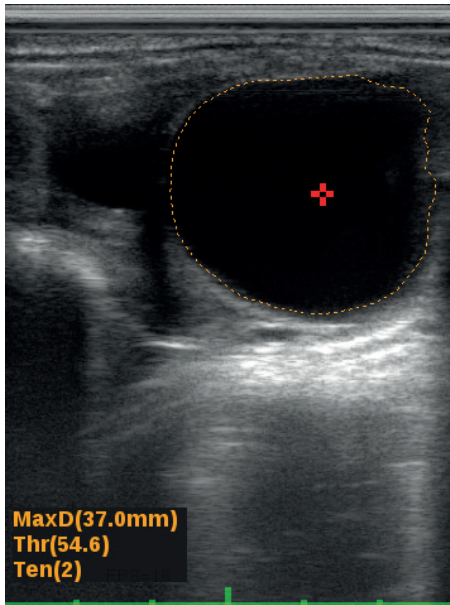

Proper follicle measurement

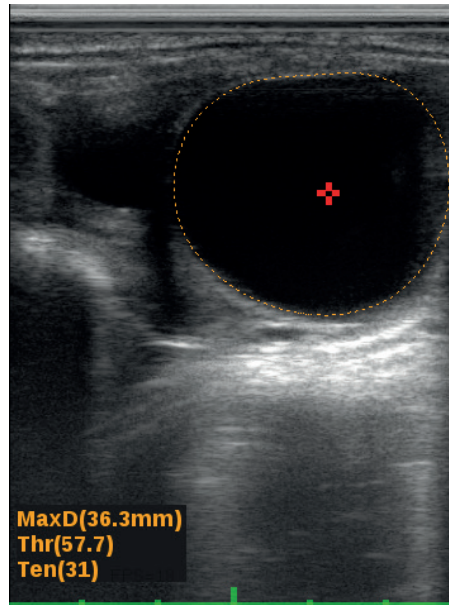

Proper follicle measurement – rounding

9.6. Cine loop

After freezing the image, you can review the test up to 14 seconds backwards.

In order to view the cine loop continuously, press the arrow up or down.

In order to stop the cine loop in a selected moment, use the arrow left or right.

In order to view the cine loop frame by frame, press the arrow left or right.

9.7. Measurements

The ultrasound scanner has measurement tools to measure: distance, surface area, volume, thickness of adipose tissue, embryo biometry.

9.7.1. Distance

In order to measure distance:

1. Freeze the image.
2. Press OK Menu.
3. Go to Measure.
4. Select Distance.
5. A red marker will appear on the screen. Set it in a selected area using the arrows.
6. Confirm the position of the marker by pressing the OK button.
7. Another marker will appear on the screen. Follow the steps in 5 and 6.
8. Distance measured between the two markers will be shown at the left bottom corner of the screen.

The user can perform up to 4 measurements in one image.

In order to make reading easier, the results are presented in the same colour as the measured distance.

9.7.2. Surface area

Surface area is calculated on the basis of two distances, in accordance with the formula: $P=A \times B$.

The result is presented in cm^2 .

In order to measure surface area of a structure:

1. Freeze the image.
2. Press OK Menu.
3. Go to Measure.
4. Select Surface area.
5. Set two measuring distances following p. 9.7.1.

9.7.3. Volume

Volume is calculated on the basis of three distances, in accordance with the formula: $P=AxBxC$.

The result is presented in cm^3 .

In order to measure volume of a structure:

1. Freeze the image.
2. Press OK Menu.
3. Go to Measure.
4. Select Volume.
5. Set three measuring distances following p. 9.7.1.

9.7.4. Measurement of adipose tissue thickness

In order to turn on the option of measurement of adipose tissue thickness:

1. Press OK Menu.
2. Go to Measure.
3. Select Backfat Settings.
4. Set Backfat = YES.
5. Freeze the image.
6. Press OK Menu.
7. Go to Measure.
8. Select Backfat.
9. A horizontal line will appear on the screen.
10. Use the UP/DOWN arrows and set the line on the border between the adipose tissue and the muscle.

9.7.5. Biometry of embryos

The ultrasound scanner enables determination of age of the embryo.

In order to turn on the biometry measurements:

1. Press OK Menu.
2. Go to Measure.
3. Go to position OB.
4. Select proper measurement.
5. Confirm your choice with the OK button.

From now on, every time you perform distance measurement, the scanner will automatically calculate the day of pregnancy on the basis of the selected biometric measurement.

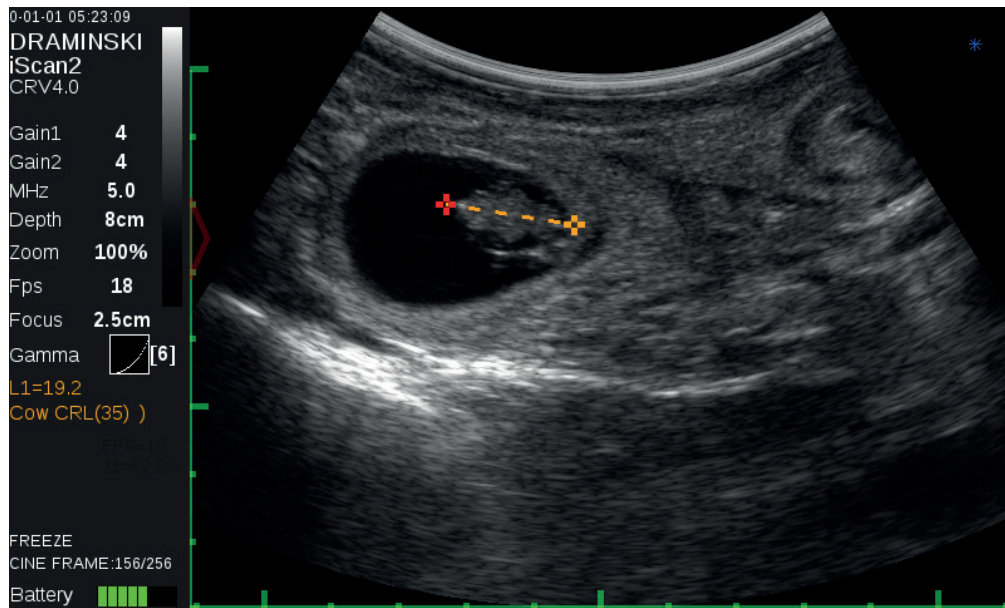

Biometric measurement „Cow CRL”

9.7.5.1. Cow CRL – embryo length

The result is presented in mm and days.

Measurement availability: from 30 to 80 day of pregnancy.

9.7.5.2. Cow BPD – head diameter measured between the fontanelles.

The result is presented in mm and days.

Measurement availability: from 65 to 200 day of pregnancy.

9.7.5.3. Horse VD – germinal vesicle size

The result is presented in mm and days.

Measurement availability: from 9 to 45 day of pregnancy.

9.7.5.4. Horse HD – head diameter

The result is presented in mm and days.

Measurement availability: between 90 and 200 day of pregnancy.

9.7.5.5. Horse OD – eye diameter

The result is presented in mm and days.

Measurement availability: between 90 and 330 day of pregnancy.

9.7.5.6. Sheep CRL – embryo length

The result is presented in mm and days.

Measurement availability: from 30 to 70 day of pregnancy.

9.7.5.7. Lama BPD – head diameter measured between the fontanelles

The result is presented in mm and days.

Measurement availability: from 75 to 240 day of pregnancy.

9.7.5.8. Pig CRL – embryo length

The result is presented in mm and days.

Measurement availability: from 20 to 50 day of pregnancy.

9.7.6. Grid

This tool projects the grid graduated 1 cm or a scope.

In order to turn on the grid:

1. Press OK Menu.
2. Go to Measure.
3. Select Grid ON/OFF.
4. Use arrows to select proper settings.
5. Confirm with the OK button.

9.8. Full screen

This option enables displaying the image at full screen without the information box.

In order to turn on Full screen:

1. Press OK Menu.
2. Go to Settings.
3. Select Full screen.
4. Use arrows to select proper settings.
5. Confirm with the OK button.

9.9. Rotate the image

This option enables rotation the image by 90° and 180°. Thanks to this, the image from the linear rectal probe can be shown at full screen. In order to use this function more comfortable, attach the carrying belts so that the ultrasound scanner was in accordance with the direction of the image.

In order to rotate the image:

1. Press OK Menu.
2. Go to Settings.
3. Go to Rotate the image.
4. Select proper direction and angle of rotation.
5. Confirm with the OK button.

When the image is rotated, all the data are show at the bottom part of the screen.

Attention! The navigation buttons show the direction in accordance with the image direction!

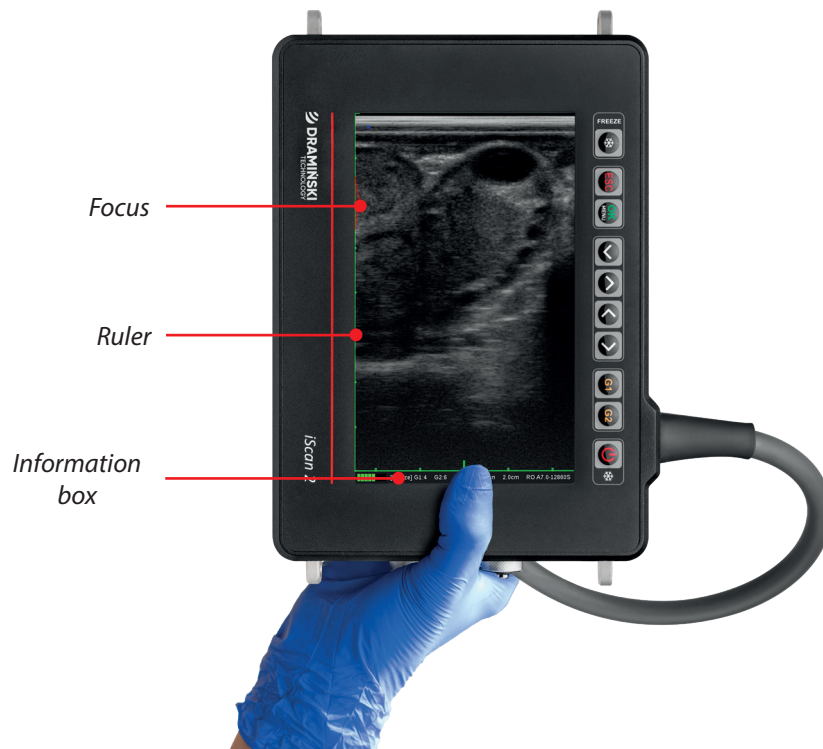

The image rotated by 90°.

9.10. How to save data

The ultrasound scanner has internal memory able to save 200 cine loops and 200 images.

If the device's memory is full, the system will start overwriting the new images and cine loops with the old records. Remember to systematically export data and archive to PC.

9.10.1. Save image

In order to save the image:

1. Freeze the image.
2. Press OK Menu.
3. Go to File.
4. Select Save image.
5. A message will appear: "Add description? Yes / No".
6. If you decide to add a description, enter the characters using the Up / Down arrows and the Left / Right arrows. The description may contain maximum 30 characters.
7. Confirm with the OK button.

Attention! The image can be saved with the marked parameters. Measurements are described in Part 9.7. To show Menu after measurement press G1 button.

9.10.2. Save cine loop

In order to save the cine loop, follow the steps described above, selecting Save Cine loop in Menu File.

9.11. How to upload the data on the screen

9.11.1. Upload image

In order to upload image:

1. Press OK Menu.
2. Go to File.
3. Select Upload image.
4. Select a file from the list. Each file has a thumbnail of the image.
5. Confirm your choice with the OK button.

9.11.2. Upload cine loop

In order to upload the cine loop, follow the steps described above, selecting Upload Cine loop in Menu File.

After uploading the cine loop on the screen, run the video sequence using the arrows Left / Right.

The arrows Up / Down enable viewing the sequence frame by frame.

9.11.3. Search images and cine loops

Images and cine loops saved in the memory can be searched by their description if this description was added.

In order to filter data by description:

1. Open the list of files using Upload Image / Upload cine loop.
2. Press G1 in order to open the Menu.
3. Select Find.
4. Enter first letters of description using navigation arrows.

9.12. How to export data to the external data storage device

The ultrasound scanner enables exporting data to external data storage USB device.

The images are exported in .BMP format, and cine loops are exported in .AVI format. The files are saved directly on the external data storage device.

In order to export data:

1. Connect data transmission cable to socket #2.
2. Connect a pendrive.
3. Press OK Menu.
4. Go to File.
5. Select Upload image or Upload cine loop.
6. Tick the selected files in the list using the Left / Right arrows.
7. Press G1 in order to open the Menu.
8. Select Send USB.
9. A dialog box will appear showing the progress of the operation.
10. When the transmissions finishes, the dialog box disappears.

9.13. How to delete data from the internal memory

In order to delete data from the internal memory:

1. Press OK Menu.
 2. Go to File.
-

3. Select Upload Image or Upload Cine loop.
4. Tick selected files in the list using the Left / Right arrows.
5. Press G1 to open the Menu.
6. Select Delete.
7. The screen will show a dialog box with the question: Delete? Are you sure? YES / NO.
8. When it is confirmed, the data will be deleted from the memory.

10. Modes of imaging

The ultrasound scanner operates in B, B+B and B+M modes.

10.1. B+B Mode

This mode is used to compare even structures (e.g. ovaries) of volume measurements, or showing the structures in different cross-sections.

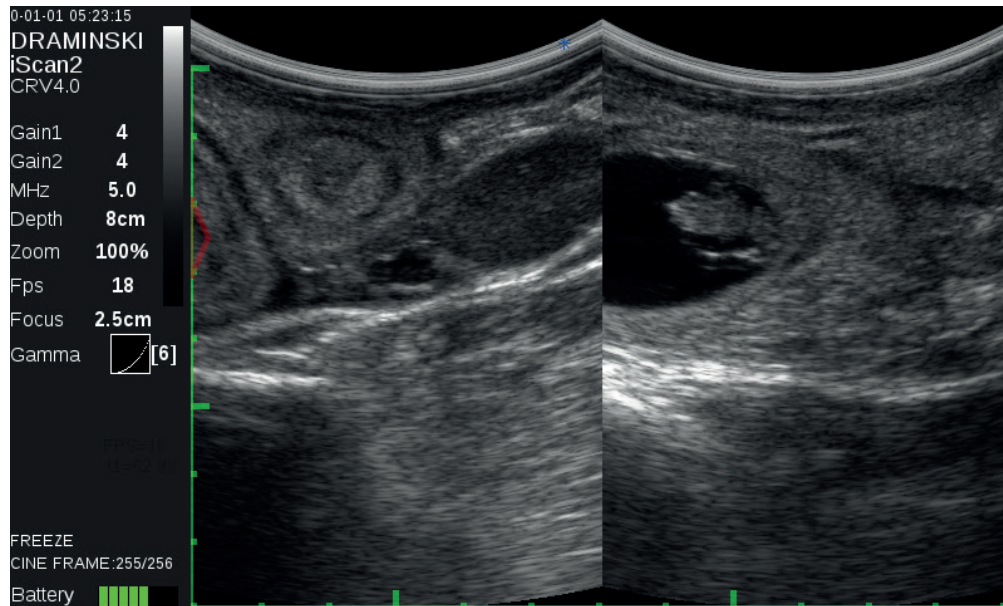

B+B Mode

In order to compare structures in B+B mode

1. Freeze the image with the structure which interests you in the middle.
2. Press OK Menu.
3. Go to Mode.
4. Select B+B.
5. The image will be moved to the right box.
6. Defreeze the image – the left box will become active.
7. Continue testing.

Attention! Measuring structures in both boxes is similar to B mode. There is no need to switch the boxes. The measuring point can be marked at any place on the screen.

10.2. B+M Mode

It is used to show changes of shape in structure in time..

In order to turn on B+M mode:

1. Open the Menu.
2. Go to Mode.
3. Select B+M.

11. System settings

11.1. Change left / right

This option enables setting the image so that the marker on the screen was corresponding to the side of the marker on the probe. It is meaningful for right- and left-handed people during rectal testing.

11.2. Date/Time

This option enables updating date and time in accordance to the calendar used by the user.

When this option is selected, a dialog box appears in which you can set date and time successively. Moving to another stage occurs after the previous setting has been confirmed.

11.3. Brightness

This option is used to adjust brightness of the monitor. You should remember that the level of brightness influences the time of battery operation. The range of adjustment is within 10% to 100%.

11.4. Language

After the language has been selected and the OK button has been pressed, the system automatically changes to the selected language version.

11.5. Default settings

This option enables restoring default settings for certain parameters of the image in the case when they are changed by the user and there is a necessity to restore standard settings. Selection of this option causes re-setting of the scanner and restoring all of the saved settings. Images and cine loops which were saved are not deleted.

11.6. Automatic turn off

This option enables setting the time after which the system automatically turns off: never, 5 min., 15 min., 30 min. 60 min.

60 seconds prior to the automatic turn off, a message appears in the screen: "Auto power OFF, 60 seconds" – the system starts counting 60 seconds till the scanner turns off. The message disappears if any of the buttons is pressed, and the system will count down the set time again.

12. Accessories

12.1. Goggle

The system of the DRAMIŃSKI head goggle guarantees clear and contrast image in sunny days. Thanks to 5-level adjustment system every user can set the displays in accordance to their preferences following the safety rules.



Goggle

Attention! It is important to be cautious regarding possible restrictions of the field vision.

In order to connect the goggle:

1. Unscrew the plug protecting the goggle socket.
2. Connect the plug of the goggle cable to the socket and tighten the protection.
3. In order to save the battery, you can turn off the screen of the ultrasound scanner by show pressing of the ESC button. After the ultrasound scanner display is turned off, the image on the goggles is displayed in full-screen mode.
4. To turn on the ultrasound scanner display again, press and hold ESC. The image will go back to standard mode.

Attention! Remember to disconnect the goggle and put the protecting plug before washing the ultrasound scanner!

Attention! It is permitted to clean the goggle with a slightly wet cloth.

12.2. Sunshield



Sunshield

The sunshield helps reduce the sun beam reflection from the monitor.

In order to attach the sunshield:

1. Prepare the scanner for operation.
2. Put the shield to the screen so that it did not cover the keyboard, the rubbered band should hang loosely from the bottom part of the scanner.
3. Put the free part of the band around the scanner, via the battery and secure it at the upper edge of the shield.

12.3. Extension for the linear rectal probe



Extension for the linear rectal probe

The extension is used to a quick endorectal test for pregnancy without necessity to insert the testing shoulder to the rectum of the animal.

12.4. WiFi antenna

The WiFi antenna allows you to send images and cine to your phone and to use our phone to take measurements. Installation of the Draminski Ultrasound Scanner app on your phone is required.

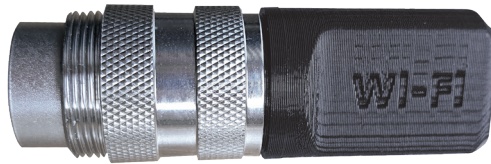

WiFi antenna

12.4.1. Connecting the phone to the ultrasound scanner:

1. Connect the antenna to the socket. The message "WiFi module connected" will appear on the screen.
2. Open the Menu and go to the Settings tab
3. Select WiFi.
4. Select WiFi access point.
5. A wireless connection icon will appear on the screen. The ultrasound scanner will create a network called Draminskiscan and start transmitting a WiFi signal.
6. On your phone, go to the WiFi settings and select the Draminskiscan network.
7. Start the Ultrasound Scanner app.

12.4.2. Turning off WiFi

If the WiFi access point is not disabled, each time the ultrasound scanner is restarted, the system will check that the WiFi antenna is connected and if it detects the connection, it will automatically start transmitting the signal.

In order to turn off WiFi:

1. Open the Menu and move to the Settings tab.
2. Select WiFi.
3. Select "Turn off WiFi". The connection icon will disappear.

13. Maintenance of the device and the probes

13.1. Washing and disinfection

Attention! Taking into account biological security, it is recommended to wash and disinfect the ultrasound scanner after you finish working with it.

Attention! Do not use hot water to wash the scanner, nor pressurized water, nor power washers! Do not immerse the scanner in a container with liquid.



Warning! Use alcohol-free agents to disinfect the probe.

It is forbidden to use highly concentrated, aggressive and abrasive agents. Such agents can permanently damage the surface of the probe, the monitor and the casing.

In order to wash the ultrasound scanner after work has been finished:

1. Tighten the protective plugs for goggle and data transmission sockets.
2. Disconnect the battery.
3. Disconnect the carrying belts.
4. Wash the ultrasound scanner in running water (you can add some soft washing agent).
5. Wipe the ultrasound scanner dry. Untighten the data transmission slot protecting plug.
6. For disinfection use a proper agent intended for disinfection of surfaces of medical and veterinary devices. Follow the instructions for the use of the product.
7. The battery should be cleaned and disinfected with wet paper towels or tissues. Do not use running water.
8. Leave the ultrasound scanner and the battery in a safe place until they dry.

The carrying case should be cleaned externally with water and detergent. The foam insert should be vacuumed regularly and cleaned with water and a mild detergent. A disinfectant solution, e.g. Virkon S, may be used for disinfection. Before using the carrying case, make sure that the foam insert is completely dry.

Attention! The transport case has an air pressure regulating valve in the closed case. It is not moisture-permeable. Do not close wet device in the case.

13.2. Technical checks

Remember, before starting work, each time check the ultrasound scanner, the battery, the probe and its cable if they are not mechanically damaged. If you notice something disturbing (for example, discontinuity of the cable), contact the service immediately.

The users of the ultrasound scanner are recommended to carry out regular technical checks at the manufacturer every two years. It will guarantee the highest safety and durability.

14. Transportation of the device

It is recommended to transport the device in the provided transport case. The layout of the elements in the case is shown in the following pictogram:



Transport case with space for an additional battery

* Optional accessory

15. Exploitation and technical notes

It is necessary to shave fur and use ultrasound gel in order to carry out abdominal tests. Proper layer of the gel will definitely improve penetration of the signals and will enable obtaining proper and legible images.

During and after the test protect the head of the probe and the cable against mechanical damage.

Remember:

1. To put the cable of the probe properly. Improper placing or excessive bending of the cable can cause damage to the wire.
2. To put the probe in the case properly. To avoid squeezing the cable by the cover of the case, as it may cut the wire.
3. To store the probe properly and safely.

Attention! If it happens that storage temperature was below 5°C, it is necessary to warm the probe before turning off the device. Using the ultrasound scanner in extreme temperatures alternatively is unfavourable and can lead to damages.

15.1. Trouble shooting

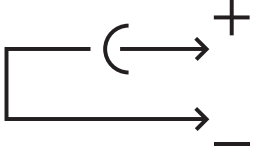
Symptoms of abnormal behaviour of the device	Control Activities
The device would not turn on	<ol style="list-style-type: none"> 4. Check if the battery is properly attached. 5. Check if the battery is charged. 6. Check if the device operates with another battery for iScan 2, if accessible. 7. After pressing Turn On button hold ESC button for about 2 s.
The image is disturbed	<ol style="list-style-type: none"> 1. Check if the ultrasound scanner is not located near other devices emitting electromagnetic waves. 2. Check of the probe cable is not damaged mechanically.
The image is too bright or too dark	<ol style="list-style-type: none"> 1. Check the settings of brightness, gain, gamma and MHz. 2. Turn on the default settings.
No signal of charging in the battery charger	<ol style="list-style-type: none"> 1. Check if the charger is properly connected to the mains. 2. Check the power supply in the mains.
After connecting the discharged battery to the battery charger, the diode of the charger is green but the battery is not charging	<ol style="list-style-type: none"> 1. Check if the connector from the battery is not reversely connected to the charger cable. Orientation of the symbols on the connector and the cable should be as shown in the scheme below. 
The battery works too short	<ol style="list-style-type: none"> 1. The battery was not charged. 2. Low temperature of the environment. 3. The battery is worn.

If none of the action presented in the table is successful, please, contact the service of the manufacturer DRAMIŃSKI, phone: +48 89 675 26 00 or e-mail: sales@draminski.com.

16. Technical data

Symbol	iS 2 C – iScan 2 with rectal convex probe iS 2 L – iScan 2 with rectal linear probe
Dimensions	220x165x67 mm (LxWxH)
Weight of the device	2400 g with the probe and the battery
Weight of the battery	460 g
Usage	Ultrasound diagnostics of animals: Diagnostics of reproductive system Confirmation and monitoring of pregnancy Measurement of adipose tissue thickness Ultrasound diagnostics of lungs, digestive system, urinary tract, motion system and the eyeball.
How the image is shown	Monitor Goggle The image is rotated by 90° left or right The image is rotated by 180°
Grey scale	256 shades
Gamma	8 settings
Monitor	Diagonal 7.0" IPS LCD LED 800x480 px
Probe	Broadband, high frequency probes: Linear rectal 7.0 MHz (from 4 to 9 MHz) Active area = 60mm, 128 elements Range up to 15 cm Convex rectal 5.0 MHz (from 3 to 7.5 MHz) Radius= 61.2 cm Scanning angle = 64 128 elements Range up to 25 cm
How the probe is connected	The probe is permanently fixed
Keyboard	Membrane, water resistant
How the image is shown	B Mode B+B Mode B+M Mode

Image management	Freeze Measuring Zooming 60–200% at 20% increments Save to internal memory Export to external storage device
Measurements	Distance, surface area (from 2 measurements), volume, grid, age tables (Cow CRL, Cow BPD, Horse DSG, Horse DO, Sheep CRL, Lama BPD), Backfat + muscle
Save data to the memory	Image with measurements Cine loop (256 frames = about 14 seconds)
Image memory	200
Cine loop memory	200
Quick access menu	Yes, customized
Presets	Yes, the user can create them
Source of power supply	Li-ion 14.4V 6.8Ah
Time of continuous operation when the battery is fully charged	Up to 7 hours
Time of charging the battery pack	4 hours
Battery discharge indicator	Automatic – graphic indicator
Impermeability to dust and water	IP65 (Complete protection against "dust tight". Protection against heavy seas or powerful jets of water)
Temperature of operation	From 5° C to +40° C
Recommended temperature of storage	From 0° C to +40° C

17. Software information

The software information is available in the Help -> About ...

Here, you can find:

- the software version
- the date and time of creation and release of the software
- IP address (if WiFi is active)
- MAC address
- amount of free memory in the system
- amount of free memory on the SD card
- CPU temperature and system shutdown limit temperature
- operating system version
- WiFi network status

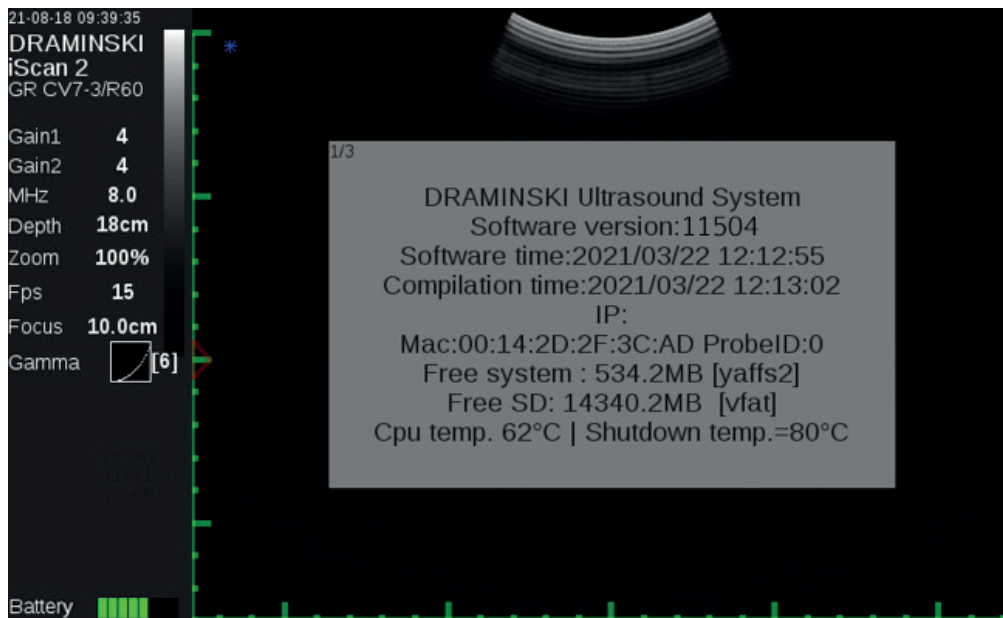

Software information

18. Demo

The demo function turns on a specially prepared presentation of several sample cine loops that demonstrate the diagnostic possibilities offered by iScan2.

To turn it on:

1. Open the Menu and select Help.
2. Select Demo. Playback of the cine loops will start automatically.

To switch off, press Freeze.

19. Warranty

The manufacturer gives a 24-month warranty and guarantees trouble-free operation of the device used in accordance with this user guide.

The battery has a 6-month warranty.

In case if a technical defect occurs, which was not caused by the user, the manufacturer is obliged to repair the device within 14 working days from the day of delivery of the device to the service (Wiktora Steffena 21, 11-036 Sząbruk, Poland) and send back the operational device to the user at the manufacturer's cost.

The warranty does not include mechanical damages, damages caused by improper use, storage and autonomous repairs.

The warranty is performed on the basis of a purchase document (invoice). In order to claim under this warranty, one should inform DRAMINIŃSKI company about the defect within a sensible period of time since the defect has been noticed, however, no later than the expiry date of the warranty.

In order to submit reclaim under this warranty, one should provide:

1. Notify DRAMINIŃSKI S.A. of the device malfunction immediately after it occurs.
2. Send the device to the Service Department (no later than before the warranty expiration date) or deliver it in person together with the proof of purchase, which should include the seller's and purchaser's details, the date and place of purchase, the device name, and its serial number.
3. A description of the malfunction must be enclosed with the device sent to the Service Department to ensure efficient diagnosis and repair of the damage:
 - Before shipping, the ultrasound device, carrying case, and all included accessories must be cleaned and disinfected (*in accordance with the Cleaning and Disinfection section),
 - Please pay particular attention when packaging the device to ensure that it is properly secured, as the manufacturer shall not be held liable for any damage incurred during transport.

The warranty is given by DRAMINIŃSKI S.A.

Wiktora Steffena 21

11-036 Sząbruk

POLAND

Phone: +48 89 675 26 00

E-mail: serwis@draminski.com

www.draminski.com



DRAMIŃSKI S.A.

Wiktora Steffena 21, 11-036 Sząbruk, POLAND

tel. +48 89 675 26 00

e-mail: sales@draminski.com

www.draminski.com
